

INNOVATION•RELIABILITY•QUALITY

TPC



2026 Dental Equipment Product Catalog



tpcdental.com

OUR VISION

A Preferred Company

To create a quality environment where people can work together to provide simple, cost effective creative solutions for the betterment of dentistry.

OUR MISSION

Continuous Improvement

We will manufacture innovative, high quality and cost effective dental products that enable distribution partners, dentists, hygienists, teaching institutions and government organizations throughout the world to perform efficient quality dental care. TPC provides innovative solutions and quality equipment that enables dental professionals to work together for the benefit of dentistry.

TABLE OF CONTENTS

Our Vision & Our Mission	Inside Front Cover
Terms & Conditions	3
Chair, Unit, Light Packages	4-11
Chairs & Delivery Units	12-34
Air Compressors / Wet Ring Vacuum Systems	35-37
Mobile & Portable Dental Systems	38-43
Extra Oral Suction System	44
Stools & X-Ray Chairs	45-48
Operatory Lights	49-53
Mobile Cabinets	54
Imaging Products & Accessories	55-63
Dental Handpiece & Parts	64-77
Handpiece Cleaning & Lubrication Systems	78
Curing & Bleaching	79-87
Scaling Products & Accessories	88-94
Ultrasonic Bath	95-98
Digital Amalgamator	99
Micro Motor & Handpiece	100
Digital Thermometer	101
Deluxe Autoclavable Valves	102
Parts & Components	103-109
Custom Length Umbilical / Utility Centers	110
Order Form	111
Corporate Staff Contacts	112
Upholstery Color Chart	113

Customer Care (8:00 a.m. – 5 p.m. PST)
 Customer Service Fax Orders
 Technical Support
 Sales Support
 International Sales
 Latin America sales
 Shipping
 Accounting
 Customer Service
 Ordering

1-626-810-4337
 1-626-810-4245
 service@tpcdental.com
 sbeckley@tpcdental.com
 dwang@tpcdental.com
 charles@tpcdental.com
 holly@tpcdental.com
 vwang@tpcdental.com
 customerservice@tpcdental.com
 customerservice@tpcdental.com



Ordering Information:

When placing orders, please include the following information. All orders will be processed upon receipt of a faxed, mailed, or e-mailed hardcopy of the purchase order.

- Model and/or Part Number
- Requested Ship Date
- Description / Voltage
- Purchase Order Number
- Quantity
- Shipping Instructions
- Cancellations must be confirmed in writing
- All credit

cards are accepted unless otherwise noted

Returned Goods:

All returns require prior authorization. Returns must be authorized by TPC within 7 days of date received by the customer.

- Contact Customer Service for Return Authorization Number
- Returned products are subject to a 25% restocking charge
- All returned goods must have Return Authorization Number
- All returned goods must be shipped prepaid
- All authorized returns must be received by TPC in original packaging, accessories, documentation and in original condition for credit considerations
- All outbound repair / warranty freight charges are the responsibly of the customer.
- **No returns accepted after 14 days.**

Special Orders:

- Special order items and custom made products are not returnable for credit

Repair Estimates:All repair estimates are \$35. If approved for repair, the \$35 will be applied to the repair invoice.

Minimum Orders:

- Orders less than \$50.00 will incur an additional \$5.00 handling charge.
- All drop ship orders will incur an additional \$5.00 fee.

Terms of Sale:

- Claims: All claims for merchandise received that are not in accordance with the original purchase order must be made within five (5) working days of the receipt of the merchandise. All merchandise is quality inspected and packaged in perfect condition. The common carrier assumes full responsibility for the safe delivery of all merchandise after it is removed from the F.O.B. shipping point. All claims for shortages, loss or damage must be documented and filed promptly with the freight carrier. Concealed damage must be reported to the freight carrier immediately upon discovery, with a request for inspection. If a request is made more than 15 days after the receipt of the merchandise, reasonable evidence must be submitted indicating that damage could not have occurred after delivery.
- All pricing in catalog is subject to change. Verify all pricing prior to placing order.

Warranty Information (All stated warranties are intended for USA market ONLY):

All of our products sold are guaranteed to be free from defects in workmanship and materials for one year from date of purchase, unless otherwise stated. TPC will repair or replace any defective part at no charge. TPC will not be responsible for labor charges or shipping charges to / from the TPC facility. This guarantee does not cover normal wear or stains on surface finish. The guarantee does not cover damage resulting from improper installation, misuse or accidents incurred in shipping and handling. All claims against the freight carrier must be initiated at the time the damaged items are received. The claim is the responsibility of the customer. We are improving our products on a continuous basis. We reserve the right to make modifications without the need for prior notification and are not obliged

Products:	Warranty Period:	Products:	Warranty Period:
Patient Chairs	5 year limited	Delivery Units	5 year Limited
Curing & Bleaching Systems	2 years	Seating	1 year
Imaging Products	1 year	Mobile Cabinets	1 year
Scaling Products	1 year	Air-Driven Handpieces	1 year
Air Compressor	5 Year limited	Amalgamator	1 year
		Vacuum Pump	5 year limited

Extended Manufacturer Warranty (selective models):

H6000, H6005, H6025, H7005 Lubrication System 2 year
 LED Curing Lights (All Models) 2 year
 Advance CAM Intraoral Camera System(s) 2 year
 LED Operatory Lights 2 year

Limited Manufacturer Warranty (selective models):

6 month Manufacturer Warranty (selective models):
 Fiber optic systems, S333, M333, QS222, QM222, ELCA760, ELS736.

Mirage 2.0

Chair Mounted Operatory System

MP2015-550LED-2.0



TP-2005 Touch Pad



Model DR-1102
Optional

Model AS-1101
Optional



MP2000-550LED-2.0

Packing Dimensions (L x W x H)	Weight
Chair: 44 x 29 x 33	340 lbs.
Cushion: 51 x 24 x 10	35 lbs.
Unit: 39 x 29 x 23	60 lbs.
Assist PKG: 43 x 25 x 12	40 lbs.
Dental Light Arm L600: 34 x 11 x 5	30 lbs.
Dental Light Head L550: 17 x 15 x 7	
Cuspidor 26 x 18 x 10	20 lbs.

Mirage 2.0

Chair Mounted Operatory System

Description	Model	Suggested Retail Price
Mirage 2.0 Operatory Package with Cuspidor	MP2000-550LED-2.0	
Mirage 2.0 Operatory Package with Assistant's Instrumentation		MP2015-550LED-2.0
Packages include the following:	(with cuspidor)	(without cuspidor)
4000-2.0 Hydraulic patient chair with wide back and full lumbar support, rotating armrests left or right, double articulating headrest with sliding height adjustment, 30 degree swivel from left and right of center, 3 programmable positions with automatic return and foot control	✓	✓
2015-2.0 Asepsis 3 Handpiece automatic control with coolant controls, flex arm with air brake, diaphragm block design, wet/dry variable speed foot control, deluxe utility center with air /water filters and regulators, master shut off valves. Includes 3 way syringe and light post with cutout for internal wires and monitor bracket Asepsis telescoping 4 position assistant's package, Hve and saliva ejector, water / air quick disconnects, solids collector clean water system	✓	✓
L550-LED Lustrous LED post mounted light with adjustable intensity, 8,000-30,000 Lux	✓	✓
2000-2.0 Porcelain cuspidor with timed bowl rinse and cup filler, telescoping 4 position assistant's package, Hve and saliva ejector, water / air quick disconnects, solids collector and clean water system	✓	

Options: "Options are not factory-installed unless specified on the purchase order. Additional charges apply." Retail

TPC3WAY-PRT	Additional autoclavable 3 way syringe with tubing
P2335+TB	Deluxe autoclavable Hve Long valve with tubing
WIC800	Standard flat screen monitor bracket
WIC825	Deluxe flat screen monitor bracket with 16" extension Arm
WIC840	Mirage flat screen monitor bracket with 16" extension Arm
MO17	17" LCD multi media flat screen monitor
A800N-1	Advance 800 piezo scaler – built in
H7000	Illumination System – ISO B (5 hole) – tubing, control box, bulb, power supply
H7040	Illumination handpiece tubing – 5 hole
H7070-LED	Fiber optic bulb cartridge
H7660	Illumination System- ISO C (6 pin) – tubing, control box, power supply
H7045	Illumination handpiece tubing- 6 pin
ALED55BN-A	LED 5W curing light – built in to dental unit
TP-2005	Touch pad control – unit head or dental chair mounted 3 preset, auto return, last position
53016-L-100	Disposable Solids Collector Trap, 2 1/8' (pack of 100)
2000-C-2.0	Mirage Cuspidor
TPE-2011	Touch pad Control - Chair & Electric Motor System touch pad
EMB-901	Built in Electric Motor System
XV100	Super thin X-ray film viewer
XV150-R	X-ray film viewer bracket (curved) for TPC Mirage unit only
AS-1101	Mirage Assistants stool
DR-1102	Mirage doctor's stool

Mirage 2.0

Chair Mounted Operatory System

MP2015-L700LED-2.0



L700-LED

2015-2.0

TP-2005 Touch Pad

M4000-2.0

Packing Dimensions (L x W x H)	Weight
Chair: 44 x 29 x 33	340 lbs.
Cushion: 51 x 24 x 10	35 lbs.
Unit: 39 x 29 x 23	60 lbs.
Assist PKG: 43 x 25 x 12	40 lbs.
Dental Light Arm L600: 34 x 11 x 5	30 lbs.
Dental Light Head L600: 17 x 15 x 7	
Cuspidor 26 x 18 x 10	20 lbs.



Model DR-1102
Optional



Model AS-1101
Optional



MP2000-L600LED-2.0

Mirage 2.0

Chair Mounted Operatory System

Description	Model	Suggested Retail Price
Mirage 2.0 Operatory Package with Cuspidor	MP2000-L700LED-2.0	
Mirage 2.0 Operatory Package with Assistant's Instrumentation		MP2015-700LED-2.0
Packages include the following:	(with cuspidor)	(without cuspidor)
4000-2.0 Hydraulic patient chair with wide back and full lumbar support, rotating armrests left or right, double articulating headrest with sliding height adjustment, 30 degree swivel from left and right of center, 3 programmable positions with automatic return and foot control	✓	✓
2015-2.0 Asepsis 3 Handpiece automatic control with coolant controls, flex arm with air brake, diaphragm block design, wet/dry variable speed foot control, deluxe utility center with air /water filters and regulators, master shut off valves. Includes 3 way syringe and light post with cutout for internal wires and monitor bracket Asepsis telescoping 4 position assistant's package, Hve and saliva ejector clean water / air quick disconnects, solids collector with touch pad control	✓	✓
L700-LED Vivid LED post mounted light with adjustable intensity, 3,000-35,000 Lux	✓	✓
2000-2.0 Porcelain cuspidor with timed bowl rinse and cup filler, telescoping 4 position assistant's package, Hve and saliva ejector, water / air quick disconnects, solids collector and clean water system	✓	

Options: "Options are not factory-installed unless specified on the purchase order. Additional charges apply." **Retail**

TPC3WAY-PRT	Additional autoclavable 3 way syringe with tubing
P2335+TB	Deluxe autoclavable Hve Long valve with tubing
WIC800	Standard flat screen monitor bracket
WIC825	Deluxe flat screen monitor bracket with 16" extension Arm
WIC840	Mirage flat screen monitor bracket with 16" extension Arm
MO17	17" LCD multi media flat screen monitor
A800N-1	Advance 800 piezo scaler – built in
H7000	Illumination System – ISO B (5 hole) – tubing, control box, bulb, power supply
H7040	Illumination handpiece tubing – 5 hole
H7070-LED	Fiber optic bulb cartridge
H7660	Illumination System- ISO C (6 pin) – tubing, control box, power supply
H7045	Illumination handpiece tubing- 6 pin
ALED55BN-A	LED 5W curing light – built in to dental unit
TP-2005	Touch pad control – unit head or dental chair mounted 3 preset, auto return, last position
53016-L-100	Disposable Solids Collector Trap, 2 1/8' (pack of 100)
AS-1101	Mirage Assistants stool
DR-1102	Mirage doctor's stool

Mirage 2.0

Chair Mounted Operatory System with Cast Aluminium Base

MP2000-550LED-2.0-CB



Optional:
3 way syringe
cuspidor

L550-LED

2015-2.0

Optional:
Highspeed Handpieces

Cast Aluminium base

4000-2.0-CB

Packing Dimensions (L x W x H)	Weight
Chair: 44 x 29 x 33	340 lbs.
Cushion: 51 x 24 x 10	35 lbs.
Unit: 39 x 29 x 23	60 lbs.
Assist PKG: 43 x 25 x 12	40 lbs.
Dental Light Arm L600: 34 x 11 x 5	30 lbs.
Dental Light Head L550: 17 x 15 x 7	
Cuspidor 26 x 18 x 10	20 lbs.



Model DR-1102
Optional



Model AS-1101
Optional

Mirage 2.0

Chair Mounted Operatory System with Cast Aluminium Base

Description	Model	Suggested Retail Price
Mirage 2.0 Operatory Package with Cuspidor	MP2000-550LED-2.0-CB	
Mirage 2.0 Operatory Package with Assistant's Instrumentation	MP2015-550LED-2.0-CB	
Packages include the following:	(with cuspidor)	(without cuspidor)
4000-2.0 Hydraulic patient chair with wide back and full lumbar support, rotating armrests left or right, double articulating headrest with sliding height adjustment, 30 degree swivel from left and right of center, 3 programmable positions with automatic return and foot control, cast aluminium base	✓	✓
2015-2.0 Asepsis 3 Handpiece automatic control with coolant controls, flex arm with air brake, diaphragm block design, wet/dry variable speed foot control, deluxe utility center with air /water filters and regulators, master shut off valves. Includes 3 way syringe and light post with cutout for internal wires and monitor bracket Asepsis telescoping 4 position assistant's package, Hve and saliva ejector, water / air quick disconnects, solids collector clean water system	✓	✓
L550-LED Lustrous LED post mounted light with adjustable intensity, 8,000-30,000 Lux	✓	✓
2000-C-2.0 Porcelain cuspidor with timed bowl rinse and cup filler, telescoping 4 position assistant's package, Hve and saliva ejector, water / air quick disconnects, solids collector and clean water system	✓	

Options: "Options are not factory-installed unless specified on the purchase order. Additional charges apply." **Retail**

TPC3WAY-PRT	Additional autoclavable 3 way syringe with tubing
P2335+TB	Deluxe autoclavable Hve Long valve with tubing
WIC800	Standard flat screen monitor bracket
WIC825	Deluxe flat screen monitor bracket with 16" extension Arm
WIC840	Mirage flat screen monitor bracket with 16" extension Arm
MO17	17" LCD multi media flat screen monitor
A800N-1	Advance 800 piezo scaler – built in
H7000	Illumination System – ISO B (5 hole) – tubing, control box, bulb, power supply
H7040	Illumination handpiece tubing – 5 hole
H7070-LED	Fiber optic bulb cartridge
H7660	Illumination System- ISO C (6 pin) – tubing, control box, power supply
H7045	Illumination handpiece tubing- 6 pin
ALED55BN-A	LED 5W curing light – built in to dental unit
TP-2005	Touch pad control – unit head or dental chair mounted 3 preset, auto return, last position
53016-L-100	Disposable Solids Collector Trap, 2 1/8' (pack of 100)
2000-C-2.0	Mirage Cuspidor
TPE-2011	Touch pad Control - Chair & Electric Motor System touch pad
EMB-901	Built in Electric Motor System
XV100	Super thin X-ray film viewer
XV150-R	X-ray film viewer bracket (curved) for TPC Mirage unit only
AS-1101	Mirage Assistants stool
DR-1102	Mirage doctor's stool

Bellagio

Chair Mounted Operatory System with Laguna 2.0 chair

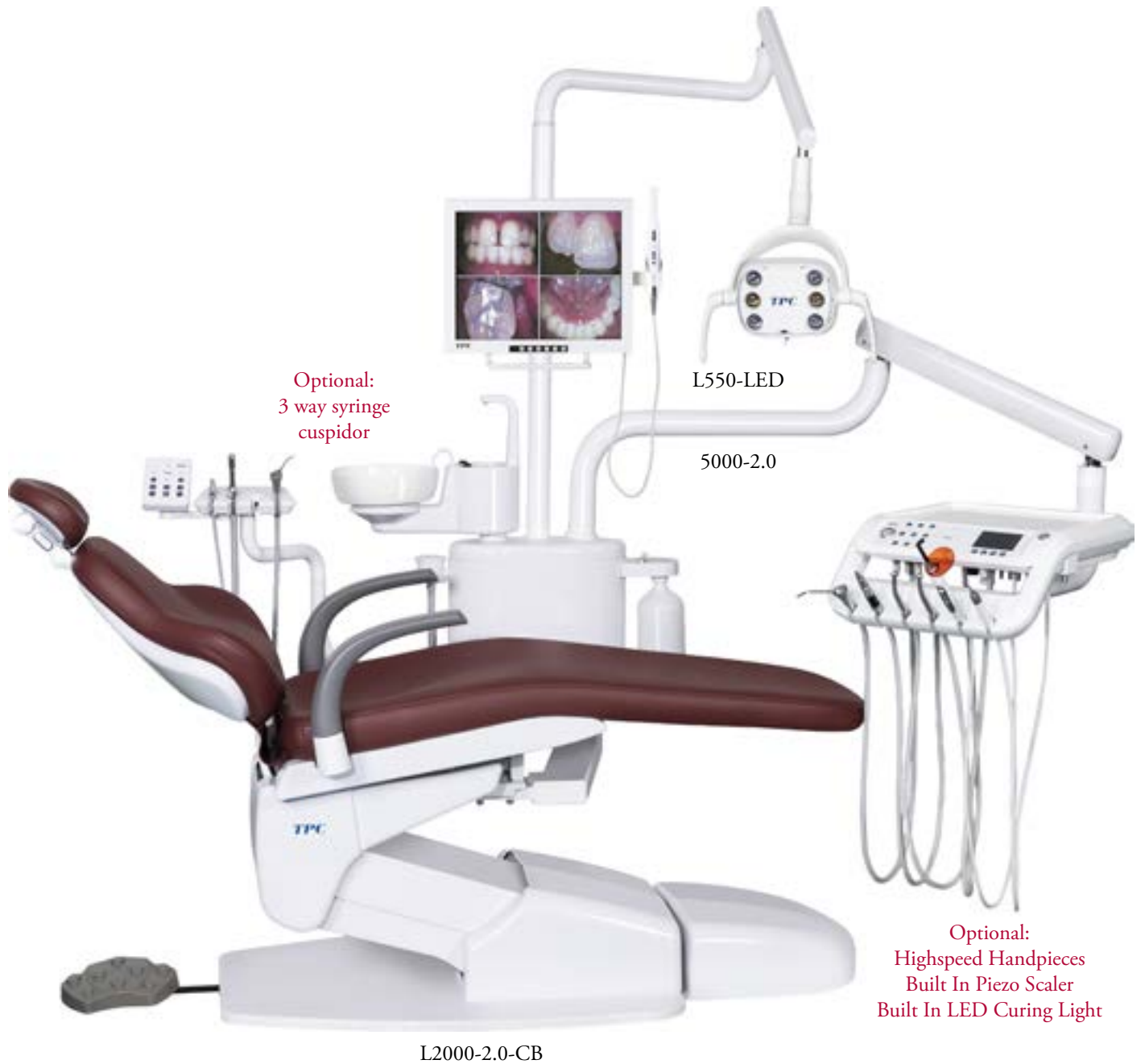

Optional:
3 way syringe
cuspidor

L550-LED

5000-2.0

Optional:
Highspeed Handpieces
Built In Piezo Scaler
Built In LED Curing Light

L2000-2.0-CB

Packing Dimensions (L x W x H)	Weight
Chair: 44 x 29 x 33	340 lbs.
Cushion: 51 x 24 x 10	35 lbs.
Unit: 39 x 29 x 23	60 lbs.
Assist PKG: 43 x 25 x 12	40 lbs.
Dental Light Arm L600: 34 x 11 x 5	30 lbs.
Dental Light Head L550: 17 x 15 x 7	
Cuspidor 26 x 18 x 10	20 lbs.



Model DR-1102
Optional



Model AS-1101
Optional

Bellagio

Chair Mounted Operatory System with Cast Aluminium Base

Description	Model	Suggested Retail Price
Bellagio Operatory Package with Cuspidor	BP5000-L7601-2.0-CB	
Bellagio Operatory Package with Assistant's Instrumentation		BP5015-L7601-2.0-CB
Packages include the following:	(with cuspidor)	(without cuspidor)
L2000-2.0	Electromechanical patient chair with wide back and full lumbar support, rotating armrests left or right, double articulating headrest with sliding height adjustment, 3 programmable positions with automatic return and foot control	✓ ✓
5015-2.0	Asepsis 3 Handpiece automatic control with coolant controls, flex arm with air brake, diaphragm block design, wet/dry variable speed foot control, deluxe utility center with air /water filters and regulators, master shut off valves. Includes 3 way syringe and light post with cutout for internal wires and monitor bracket Asepsis telescoping 4 position assistant's package, Hve and saliva ejector, water / air quick disconnects, solids collector clean water system, intergrated Piezo Scaler, internal timer, intergrated touch pad controls	✓ ✓
L550-LED	Luminous LED post mounted light with adjustable intensity, 8,000-30,000 Lux	✓ ✓
2000-C-2.0	Porcelain cuspidor with timed bowl rinse and cup filler, telescoping 4 position assistant's package, Hve and saliva ejector, water / air quick disconnects, solids collector and clean water system	✓

Options: "Options are not factory-installed unless specified on the purchase order. Additional charges apply." **Retail**

TPC3WAY-PRT	Additional autoclavable 3 way syringe with tubing
P2335+TB	Deluxe autoclavable Hve Long valve with tubing
WIC800	Standard flat screen monitor bracket
WIC825	Deluxe flat screen monitor bracket with 16" extension Arm
WIC840	Mirage flat screen monitor bracket with 16" extension Arm
MO17	17" LCD multi media flat screen monitor
H7000	Illumination System – ISO B (5 hole) – tubing, control box, bulb, power supply
H7040	Illumination handpiece tubing – 5 hole
H7070-LED	Fiber optic bulb cartridge
H7660	Illumination System- ISO C (6 pin) – tubing, control box, power supply
H7045	Illumination handpiece tubing- 6 pin
ALED55BN-A	LED 5W curing light – built in to dental unit
TP-2005	Touch pad control – unit head or dental chair mounted 3 preset, auto return, last position
53016-L-100	Disposable Solids Collector Trap, 2 1/8' (pack of 100)
2000-C-2.0	Mirage Cuspidor
TPE-2011	Touch pad Control - Chair & Electric Motor System touch pad
EMB-901	Built in Electric Motor System
XV100	Super thin X-ray film viewer
XV150-R	X-ray film viewer bracket (curved) for TPC Mirage unit only
AS-1101	Mirage Assistants stool
DR-1102	Mirage doctor's stool

Bellagio

Chair Mounted Operatory System with Cast Aluminium Base

BP5000-L7601LED-2.0-



Optional:
3 way syringe
cuspidor

L7601-LED

5000-2.0

Optional:
Highspeed Handpieces

Cast Aluminium base

4000-2.0-CB

Packing Dimensions (L x W x H)	Weight
Chair: 44 x 29 x 33	340 lbs.
Cushion: 51 x 24 x 10	35 lbs.
Unit: 39 x 29 x 23	60 lbs.
Assist PKG: 43 x 25 x 12	40 lbs.
Dental Light Arm L600: 34 x 11 x 5	30 lbs.
Dental Light Head L550: 17 x 15 x 7	
Cuspidor 26 x 18 x 10	20 lbs.



Model DR-1102
Optional



Model AS-1101
Optional

Bellagio

Chair Mounted Operatory System with Cast Aluminium Base

Description	Model	Suggested Retail Price	
Bellagio Operatory Package with Cuspidor	BP5000-L7601-2.0-CB		
Bellagio Operatory Package with Assistant's Instrumentation		BP5015-L7601-2.0-CB	
Packages include the following:	(with cuspidor)	(without cuspidor)	
4000-2.0	Hydraulic patient chair with wide back and full lumbar support, rotating armrests left or right, double articulating headrest with sliding height adjustment, 30 degree swivel from left and right of center, 3 programmable positions with automatic return and foot control, cast aluminium base	✓	✓
5015-2.0	Asepsis 3 Handpiece automatic control with coolant controls, flex arm with air brake, diaphragm block design, wet/dry variable speed foot control, deluxe utility center with air /water filters and regulators, master shut off valves. Includes 3 way syringe and light post with cutout for internal wires and monitor bracket Asepsis telescoping 4 position assistant's package, Hve and saliva ejector, water / air quick disconnects, solids collector clean water system, intergrated Piezo Scaler, internal timer, intergrated touch pad controls	✓	✓
L7601-LED	Luminous LED post mounted light with adjustable intensity, 8,000-30,000 Lux	✓	✓
2000-C-2.0	Porcelain cuspidor with timed bowl rinse and cup filler, telescoping 4 position assistant's package, Hve and saliva ejector, water / air quick disconnects, solids collector and clean water system	✓	✓

Options: "Options are not factory-installed unless specified on the purchase order. Additional charges apply." **Retail**

TPC3WAY-PRT	Additional autoclavable 3 way syringe with tubing
P2335+TB	Deluxe autoclavable Hve Long valve with tubing
WIC800	Standard flat screen monitor bracket
WIC825	Deluxe flat screen monitor bracket with 16" extension Arm
WIC840	Mirage flat screen monitor bracket with 16" extension Arm
MO17	17" LCD multi media flat screen monitor
H7000	Illumination System – ISO B (5 hole) – tubing, control box, bulb, power supply
H7040	Illumination handpiece tubing – 5 hole
H7070-LED	Fiber optic bulb cartridge
H7660	Illumination System- ISO C (6 pin) – tubing, control box, power supply
H7045	Illumination handpiece tubing- 6 pin
ALED55BN-A	LED 5W curing light – built in to dental unit
TP-2005	Touch pad control – unit head or dental chair mounted 3 preset, auto return, last position
53016-L-100	Disposable Solids Collector Trap, 2 1/8' (pack of 100)
2000-C-2.0	Mirage Cuspidor
TPE-2011	Touch pad Control - Chair & Electric Motor System touch pad
EMB-901	Built in Electric Motor System
XV100	Super thin X-ray film viewer
XV150-R	X-ray film viewer bracket (curved) for TPC Mirage unit only
AS-1101	Mirage Assistants stool
DR-1102	Mirage doctor's stool

Mirage 2.0

Chair Mounted Operatory System

MP2015-L600LED-2.0



TP-2005 Touch Pad

M4000-2.0

Packing Dimensions (L x W x H)	Weight
Chair: 44 x 29 x 33	340 lbs.
Cushion: 51 x 24 x 10	35 lbs.
Unit: 39 x 29 x 23	60 lbs.
Assist PKG: 43 x 25 x 12	40 lbs.
Dental Light Arm L600: 34 x 11 x 5	30 lbs.
Dental Light Head L600: 17 x 15 x 7	
Cuspidor 26 x 18 x 10	20 lbs.



Model DR-1102
Optional



Model AS-1101
Optional



MP2000-L600LED-2.0

Mirage 2.0

Chair Mounted Operatory System

Description	Model	Suggested Retail Price
Mirage 2.0 Operatory Package with Cuspidor	MP2000-600LED-2.0	
Mirage 2.0 Operatory Package with Assistant's Instrumentation		MP2015-600LED-2.0
Packages include the following:	(with cuspidor)	(without cuspidor)
4000-2.0 Hydraulic patient chair with wide back and full lumbar support, rotating armrests left or right, double articulating headrest with sliding height adjustment, 30 degree swivel from left and right of center, 3 programmable positions with automatic return and foot control	✓	✓
2015-2.0 Asepsis 3 Handpiece automatic control with coolant controls, flex arm with air brake, diaphragm block design, wet/dry variable speed foot control, deluxe utility center with air /water filters and regulators, master shut off valves. Includes 3 way syringe and light post with cutout for internal wires and monitor bracket Asepsis telescoping 4 position assistant's package, Hve and saliva ejector clean water / air quick disconnects, solids collector with touch pad control	✓	✓
L600-LED Lucent LED post mounted light with adjustable intensity, 3,000-35,000 Lux	✓	✓
2000-2.0 Porcelain cuspidor with timed bowl rinse and cup filler, telescoping 4 position assistant's package, Hve and saliva ejector, water / air quick disconnects, solids collector and clean water system	✓	

Options: "Options are not factory-installed unless specified on the purchase order. Additional charges apply." Retail

TPC3WAY-PRT	Additional autoclavable 3 way syringe with tubing
P2335+TB	Deluxe autoclavable Hve Long valve with tubing
WIC800	Standard flat screen monitor bracket
WIC825	Deluxe flat screen monitor bracket with 16" extension Arm
WIC840	Mirage flat screen monitor bracket with 16" extension Arm
MO17	17" LCD multi media flat screen monitor
A800N-1	Advance 800 piezo scaler – built in
H7000	Illumination System – ISO B (5 hole) – tubing, control box, bulb, power supply
H7040	Illumination handpiece tubing – 5 hole
H7070-LED	Fiber optic bulb cartridge
H7660	Illumination System- ISO C (6 pin) – tubing, control box, power supply
H7045	Illumination handpiece tubing- 6 pin
ALED55BN-A	LED 5W curing light – built in to dental unit
TP-2005	Touch pad control – unit head or dental chair mounted 3 preset, auto return, last position
53016-L-100	Disposable Solids Collector Trap, 2 1/8' (pack of 100)
AS-1101	Mirage Assistants stool
DR-1102	Mirage doctor's stool

Mirage 2.0

Swing Mount Operatory System

#MSP3500-2.0



Optional: Unit mounted light post LP100 & L600-LED Light Post Mounted LED Light



#L600 LED



Touchpad
TP-2005



Optional: LP100 swing mount light post with optional L600-LED Operatory Light



Optional: Model #L690-LED Ceiling mounted LED operatory light

Packing Dimensions (L x W x H)	Weight
Chair: 44 x 29 x 33	340 lbs.
Cushion: 51 x 24 x 10	35 lbs.
3500: 36 x 28 x 39	100 lbs.
3550: 29 x 12 x 24	25 lbs.
LP100: 45 x 26 x 44	30 lbs.

Mirage 2.0

Swing Mount Operatory System

Description	Model	Suggested Retail Price
Mirage 2.0 Swing Mount Operatory System (without light)	MSP3500-2.0	
Packages include the following:		
4000-2.0 Hydraulic patient chair with wide back and full lumbar support, rotating armrests left or right, double articulating headrest with sliding height adjustment, 30 degree swivel from left and right of center, 4 programmable positions with automatic return and foot control		✓
3500-2.0 Rotating asepsis 3 Handpiece automatic control with coolant controls, flex arm with air brake, diaphragm block design, wet/dry variable speed foot control, deluxe utility center with air /water filters and regulators, master shut off valves. Includes 3 way syringe and clean water system, with touch pad control		✓
3550-2.0 Rear radius asepsis assistant's arm system, Hve and saliva ejector, water quick disconnect and solids collector		✓

Options: "Options are not factory-installed unless specified on the purchase order. Additional charges apply." **Retail**

3500-2.0	Mirage swing mount unit with chair bracket (for TPC chair only)
3550-2.0	Mirage rear swing mount suction package (for TPC chair only)
LP-100	Mirage swing mount light post (ordered w/unit)
LP-105	Mirage swing mount monitor post with monitor mounting bracket (ordered w/unit)
L600-LED	Lucent LED Operatory Light
L690-LED	Lucent LED Ceiling Mounted Operatory Light
L550-LED	Lustrous LED Operatory Light
TPC3WAY-PR T	Additional autoclavable 3 way syringe with tubing
P2335+TB	Deluxe autoclavable Hve Long valve with tubing
WIC800	Standard flat screen monitor bracket
WIC825	Deluxe flat screen monitor bracket with 16" extension
WIC840	Mirage flat screen monitor bracket with 16" extension
MO17	17" LCD multi media flat screen monitor
A800N-1	Advance 800 piezo scaler – built in
H7000	Illumination System – ISO B (5 hole) – tubing, control box, bulb, power supply
H7040	Illumination handpiece tubing – 5 hole
H7070-LED	Fiber optic bulb cartridge
H7660	Illumination System – ISO C (6 pin) – tubing, control box, power supply
H7045	Illumination handpiece tubing – 6 pin
ALED55BN-A	LED 5W curing light – built in to dental unit
TP-2005	Touch pad control – unit head or dental chair mounted 3 preset, auto return, last position, Light on / off, Cuspidor Control
XV100	Super thin X-ray film viewer
XV150-R	X-ray film viewer bracket (curved) for TPC Mirage Unit only
TPCRDSBRKT	TPC Radius Bracket
53016-L	Disposable Solids Collector Trap 2 1/8" (pack of 100)
TPE-2011	Touch pad Control - Chair & Electric Motor System Touch pad
EMB-901	Built in Electric Motor System
AS-1101	Mirage Assistants stool
DR-1102	Mirage doctor's stool

Bellagio

Swing Mount Operatory System

#BSP-5500-2.0



Optional:
TP-2005 for 3550

Optional: Unit mounted light
post LP100 & L600-LED Light
Post Mounted LED Light

#L7601-LED



Optional: LP100 swing mount light post
with optional L600-LED Operatory Light



Optional: Model #L795-LED
Ceiling mounted LED operatory light

Packing Dimensions (L x W x H)	Weight
Chair: 44 x 29 x 33	340 lbs.
Cushion: 51 x 24 x 10	35 lbs.
5500: 36 x 28 x 39	100 lbs.
3550: 29 x 12 x 24	25 lbs.
LP100: 45 x 26 x 44	30 lbs.

Bellagio

Swing Mount Operatory System

Description	Model	Suggested Retail Price
Bellagio 2.0 Swing Mount Operatory System (without light)	BSP5500-2.0	
Packages include the following:		
4000-2.0 Hydraulic patient chair with wide back and full lumbar support, rotating armrests left or right, double articulating headrest with sliding height adjustment, 30 degree swivel from left and right of center, 4 programmable positions with automatic return and foot control, ultraleather upholstery		✓
5500-2.0 Rotating asepsis 3 Handpiece automatic control with coolant controls, flex arm with air brake, diaphragm block design, wet/dry variable speed foot control, deluxe utility center with air /water filters and regulators, master shut off valves. Includes 3 way syringe and clean water system, intergrated Piezo Scaler, internal timer, intergrated touch pad controls		✓
3550-2.0 Rear radius asepsis assistant's arm system, Hve and saliva		✓

Options: "Options are not factory-installed unless specified on the purchase order. Additional charges apply." **Retail**

5500-2.0	Bellagio swing mount unit with chair bracket (for TPC chair only)
3550-2.0	Mirage rear swing mount suction package (for TPC chair only)
LP-100	Mirage swing mount light post (ordered w/unit)
LP-105	Mirage swing mount monitor post with monitor mounting bracket (ordered w/unit)
L600-LED	Lucent LED Operatory Light
L690-LED	Lucent LED Ceiling Mounted Operatory Light
L550-LED	Lustrous LED Operatory Light
L7601-LED	Luminous LED Operatory Light
L700-LED	Vivid LED Operatory Light
TPC3WAY-PR T	Additional autoclavable 3 way syringe with tubing
P2335+TB	Deluxe autoclavable Hve Long valve with tubing
WIC800	Standard flat screen monitor bracket
WIC825	Deluxe flat screen monitor bracket with 16" extension
WIC840	Mirage flat screen monitor bracket with 16" extension
MO17	17" LCD multi media flat screen monitor
H7000	Illumination System – ISO B (5 hole) – tubing, control box, bulb, power supply
H7040	Illumination handpiece tubing – 5 hole
H7070-LED	Fiber optic bulb cartridge
H7660	Illumination System – ISO C (6 pin) – tubing, control box, power supply
H7045	Illumination handpiece tubing – 6 pin
ALED55BN-A	LED 5W curing light – built in to dental unit
TP-2005	Touch pad control – unit head or dental chair mounted 3 preset, auto return, last position, Light on / off, Cuspidor Control
XV100	Super thin X-ray film viewer
XV150-R	X-ray film viewer bracket (curved) for TPC Mirage Unit only
TPCRDSBRKT	TPC Radius Bracket
53016-L	Disposable Solids Collector Trap 2 1/8" (pack of 100)
TPE-2011	Touch pad Control - Chair & Electric Motor System Touch pad
EMB-901	Built in Electric Motor System
AS-1101	Mirage Assistants stool

Mirage 2.0

Patient Chair



Model #4000-2.0

Foot Control

Hands-free positioning of the patient. 2-programmable positions plus an entry/exit position and last position.



Steel base with high durability plastic cover



Armrests swing-out for patient entry and exit from the chair



Re-enforced seat upholstery provides extra comfort and high durability



Articulating dual axis headrest rotation allows for optimum positioning of the oral cavity without the need to reposition the chair



Locking lever allows user to lock chair into desired position



Seat rotates 30° to left and right of center to accommodate different working styles and to maximize access to intraoral x-ray system



Safety shut-off plate disables seat down/backrest recline functions to prevent injury to the operator or damage to items beneath the plate.

Specifications:

Lifting/lowering mechanism:	Hydraulic, cantilever type
Initial height/stroke:	15.5" / 15"
Backrest reclining angle:	0° (Horizontal) – 70°
Seat tilting:	10° – 20°, synchronized with backrest
Preset position:	Microcomputer control. Three preset position, autoreturn, last position
Chair rotation angle:	30° left / 30° right of centerline
Headrest:	Dual axis type
Safety shut-off plate:	Under the main link
Emergency stop:	Any switch can cancel chair movement
Warranty:	5 Year Limited

Standard Features:

- Synchronous backrest
- Articulating dual axis headrest
- Steel plate base
- Swing-away armrests
- Programmable foot control
- Long pump cover

Mirage 2.0

Patient Chair

Description

Mirage 2.0 Hydraulic Patient Chair

Product includes the following:

- Two programmable positions
- One preset exit position
- Electronic foot control with auto return function
- Built-in fuse / surge protection
- Toe guard protection to prevent scuffing
- All-metal construction
- Safety shut-off base plate
- Double articulating headrest, adjustable for height and wheelchair positioning
- Locking swivel, 60 degree
- Pivoting armrests for easy entry to and exit from chair
- Seamless Upholstery
- Wide chair back
- Coordinated leg rest tilt
- Input voltage 110V or 220V

Model

#4000-2.0

Suggested Retail Price

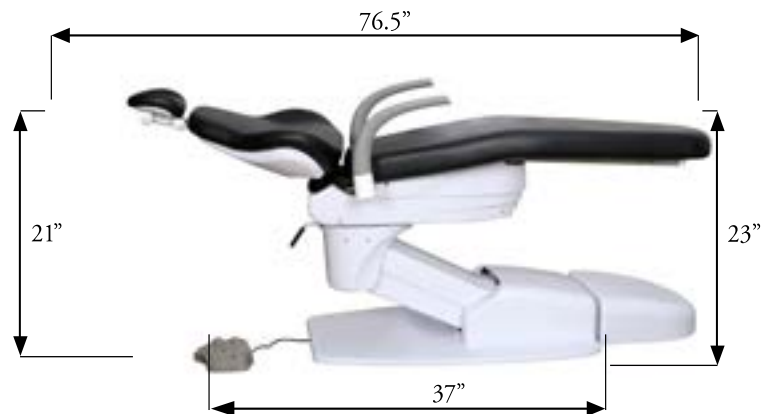

Standard: PC-1000-DU
Wide backrest



Optional: TP-2005 Touch pad control installed on dental chair

Packing Dimensions (L x W x H)	Weight
Chair: 44 x 29 x 34	340 lbs.
Cushion: 51 x 24 x 10	35 lbs.
Chair Bracket 11 x 5 x 25	35 lbs.

Options: "Options are not factory-installed unless specified on the purchase order. Additional charges apply."

Retail

- TP-2005 Touch pad control – unit head or dental chair mounted, 3 preset, auto return, last position
- TPCBRKT TPC post mount chair bracket
- PC-1000-DU Replacement Dental Chair Upholstery Duration Vinyl -Wide Back
- PC-1000-Vinyl-UC Upcharge Non-Standard Dental Chair Upholstery Vinyl -Wide Back
- PC-1000-ULTR-UC Upcharge Ultra leather Dental Chair Upholstery leather -Wide Back
- PC-1000-PR-UC Upcharge Nauga Soft Dental Chair Upholstery Vinyl -Wide Back (PR50, 49, 47, 40, 37)

* Specify color and product code when ordering *

Mirage 2.0

Patient Chair With Cast Aluminium Base



Model #4000-2.0-CB

Foot Control

Hands-free positioning of the patient. 2-programmable positions plus an entry/exit position and last position.



Cast Aluminium Chair Base



Armrests swing-out for patient entry and exit from the chair



Re-enforced seat upholstery provides extra comfort and high durability



Articulating dual axis headrest rotation allows for optimum positioning of the oral cavity without the need to reposition the chair



Locking lever allows user to lock chair into desired position



Seat rotates 30° to left and right of center to accommodate different working styles and to maximize access to intraoral x-ray system



Safety shut-off plate disables seat down/backrest recline functions to prevent injury to the operator or damage to items beneath the plate.

Specifications:

Lifting/lowering mechanism:	Hydraulic, cantilever type
Initial height/stroke:	15.5" / 15"
Backrest reclining angle:	0° (Horizontal) – 70°
Seat tilting:	10° – 20°, synchronized with backrest
Preset position:	Microcomputer control. Three preset position, autoreturn, last position
Chair rotation angle:	30° left / 30° right of centerline
Headrest:	Dual axis type
Safety shut-off plate:	Under the main link
Emergency stop:	Any switch can cancel chair movement
Warranty	5 Year Limited

Standard Features:

- Synchronous backrest
- Articulating dual axis headrest
- Cast aluminium base
- Swing-away armrests
- Programmable foot control
- Long pump cover

Mirage 2.0

Patient Chair With Cast Aluminium Base

Description

Model

Suggested Retail Price

Mirage 2.0 Hydraulic Patient Chair

#4000-2.0-CB

Product includes the following:

- Cast Aluminium Base
- Two programmable positions
- One preset exit position
- Electronic foot control with auto return function
- Built-in fuse / surge protection
- Toe guard protection to prevent scuffing
- All-metal construction
- Safety shut-off base plate
- Double articulating headrest, adjustable for height and wheelchair positioning
- Locking swivel, 60 degree
- Pivoting armrests for easy entry to and exit from chair
- Seamless Upholstery
- Wide chair back
- Coordinated leg rest tilt
- Input voltage 110V or 220V



Standard: PC-1000-DU
Wide backrest



Optional: TP-2005 Touch pad control installed on dental chair

Packing Dimensions (L x W x H)	Weight
Chair: 44 x 29 x 34	340 lbs.
Cushion: 51 x 24 x 10	35 lbs.
Chair Bracket 11 x 5 x 25	35 lbs.

Options: "Options are not factory-installed unless specified on the purchase order. Additional charges apply."

Retail

- TP-2005 Touch pad control – unit head or dental chair mounted, 3 preset, auto return, last position
- TPCBRKT TPC post mount chair bracket
- PC-1000-DU Replacement Dental Chair Upholstery Duration Vinyl -Wide Back
- PC-1000-Vinyl-UC Upcharge Non-Standard Dental Chair Upholstery Vinyl -Wide Back
- PC-1000-ULTR-UC Upcharge Ultra leather Dental Chair Upholstery leather -Wide Back
- PC-1000-PR-UC Upcharge Nauga Soft Dental Chair Upholstery Vinyl -Wide Back (PR50, 49, 47, 40, 37)

* Specify color and product code when ordering *

Mirage 2.0

Orthodontic Hydraulic Patient Chair



Model #3000-2.0

Foot Control

Hands-free positioning of the patient. 2-programmable positions plus an entry/exit position and last position.



Steel base with high durability plastic cover



Re-enforced seat upholstery provides extra comfort and high durability



Articulating dual axis headrest rotation allows for optimum positioning of the oral cavity without the need to reposition the chair



Locking lever allows user to lock chair into desired position



Seat rotates 30° to left and right of center to accommodate different working styles and to maximize access to intraoral x-ray system



Safety shut-off plate disables seat down/backrest recline functions to prevent injury to the operator or damage to items beneath the plate.

Specifications:

Lifting/lowering mechanism:	Hydraulic, cantilever type
Initial height/stroke:	15.5" / 15"
Backrest reclining angle:	0° (Horizontal) – 70°
Seat tilting:	10° – 20°, synchronized with backrest
Preset position:	Microcomputer control. Three preset position, autoreturn, last position
Chair rotation angle:	30° left / 30° right of centerline
Headrest:	Dual axis type
Safety shut-off plate:	Under the main link
Emergency stop:	Any switch can cancel chair movement
Warranty	5 Year Limited

Standard Features:

- Synchronous backrest
- Articulating dual axis headrest
- Cast aluminum base
- Programmable foot control
- Short pump cover

Mirage 2.0

Orthodontic Hydraulic Patient Chair

Description

Mirage 2.0 Orthodontic Hydraulic Patient Chair

Model

#3000-2.0

Suggested Retail Price

Packages include the following:

- Two programmable positions
- One preset exit position
- Electronic foot control with auto return function
- Built-in fuse / surge protection
- Toe guard protection to prevent scuffing
- All-metal construction
- Safety shut-off base plate
- Double articulating headrest, adjustable for height and wheelchair positioning
- Locking swivel, 60 degree
- Seamless Upholstery
- Coordinated leg rest tilt
- Input voltage 110V or 220V



Optional: TP-2005 Touchpad control installed on dental chair



Options: "Options are not factory-installed unless specified on the purchase order. Additional charges apply."

Retail

TP-2005	Touch pad control – unit head or dental chair mounted, 3 preset, auto return, last position
TPC BRKT	TPC Post mount chair bracket
PC-1000-DU	Replacement Dental Chair Upholstery-Wide Back Duration Vinyl- Specify Color and Product Code
PC-1000-Vinyl-UC	Upcharge Non-Standard Dental Chair Upholstery-Wide Back Vinyl- Specify Color and Product Code
PC-1000-ULTR-UC	Upcharge Ultra leather Dental Chair Upholstery-Wide Back Ultra leather- Specify Color and Product Code
PC-1000-PR-UC	Upcharge Nauga Soft Dental Chair Upholstery-Wide Back Nauga Soft- Specify Color and Product Code (PR50, 49, 47, 40, 37)
M4000-09	Magnetic Pillow Headrest

Packing Dimensions (L x W x H)	Weight
Chair: 44 x 29 x 33	340 lbs.
Cushion: 51 x 24 x 10	35 lbs.

Mirage 2.0

Orthodontic Package

Standard Features:

- Synchronous backrest
- Articulating dual axis headrest
- Laser Cut Steel
- Programmable foot control
- Long pump cover
- Hydraulic pump for quiet operation

Standard Features:

- Integrated non cure mode
- 24V DC power Supply
- Bulb type: 4 White LEDs 2 Yellow
- Light intensity (Lux):
High 30,000;
Low 8,000
- Focal length: 27" (70 cm)
- Illumination area: 100mm x180mm
- Sensor mode only

Standard Control Features:

- 3 HP Automatic selection
- 3-way Syringe
- Vacuum package with saliva ejector and hve
- Self contained water bottle system
- Variable speed disc-type foot control
- Water coolant on/off switch with flow control
- 1 Year warranty
- Requires central air and vacuum for plumbing



L550-LED

4000-2.0

OMC2375

MOP3000-L550LED-2.0

Optional:

OMC-2200
LCD Bracket

Optional: Magnetic
headrest

Counter top
dimensions

Rear cabinet
door view

Pull out writing
surface

Packing Dimensions (L x W x H)	Weight
Chair: 44 x 29 x 33	340 lbs.
Cushion: 51 x 24 x 10	35 lbs.
Light Arm L600 26 x 14 x 8	30 lbs.
Light Head L550 17 x 15 x 7	
Cabinet 32 x 28 x 41	140 lbs.

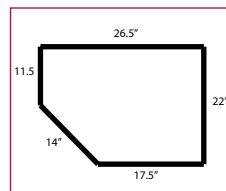

Mirage 2.0

Orthodontic Package

Description	Model	Suggested Retail Price
-------------	-------	------------------------

Mirage 2.0 Orthodontic Package	MOP3000-550LED-2.0	
--------------------------------	--------------------	--

Packages include the following:

3000-2.0 Hydraulic patient chair with wide back and full lumbar support, double articulating headrest with sliding height adjustment, 30 degree swivel from left and right of center, 4 programmable positions with automatic return and foot control	✓
---	---

OMC2375 This orthodontic mobile delivery cabinet offers a pullout writing surface, two instrument drawers, one medium and two large storage drawers for materials and supplies that fully extend and quickly remove for easy cleaning. In addition, these cabinets provide a large open space for accessories with convenient access from the front. Oversized locking dual-caster wheel	✓
--	---

L550-LED Lustrous LED operatory light with Poliblock mode 8,000 - 30,000 LUX , dual axis light head rotation	✓
--	---

TPCBRKT The chair bracket is included at no charge (value: \$290) when purchasing the Mirage Orthodontic Package	✓
--	---

Options: "Options are not factory-installed unless specified on the purchase order. Additional charges apply."

Retail

WIC840	Mirage flat screen monitor bracket with 16" extension
MO17	17" LCD multi media flat screen monitor
H7000	Illumination System – ISO B (5 hole) – tubing, control box, bulb, power supply
H7660	Illumination System – ISO C (6 pin) – tubing, control box, power supply
ALED55BN-A	LED 5W curing light – built in to dental unit
TP-2005	Touch pad control – dental chair mounted 3 preset, auto return, last position
OMC2200	LCD monitor bracket
53016-L-100	Disposable Solids Collector Trap 2 1/8" (Pack of 100)
OMC-ST81	Optional Stone Surface on OMC 2375, Color Artic
OMC-ST82	Optional Stone Surface on OMC 2375, Color White
OMC-ST85	Optional Stone Surface on OMC 2375, Color Cream
OMC-ST86	Optional Stone Surface on OMC 2375, Color Bamboo
M4000-09	Optional Magnetic Headrest
AS-1101	Mirage Assistants stool
DR-1102	Mirage doctor's stool

Optional: Stone Counter top
OMC-ST81



Optional: Stone Counter top
OMC-ST82



Optional: Stone Counter top
OMC-ST85



Optional: Stone Counter top
OMC-ST86



Laguna 2.0

Electromechanical Patient Chair



Model#L2000-2.0

Foot Control
Hands-free positioning of the patient.
2-programmable positions plus an entry/exit position.



Wide backrest provides extra comfort and durability



Articulating dual axis headrest rotation allows for optimum positioning of the oral cavity without the need to reposition the chair



Armrests pivot in and out for patient entry and exit from the chair



Solid steel base

Specifications:

Lifting/lowering mechanism:	Electromechanical, cantilever type
Initial height/stroke:	15.5" / 15"
Backrest reclining angle:	0° (Horizontal) – 70°
Seat tilting:	10° – 20°, synchronized with backrest
Preset position:	Microcomputer control. Three preset position, auto return, last position
Chair rotation angle:	Fixed
Headrest:	Dual axis type
Safety shut-off plate:	Under the main link
Emergency stop:	Any switch can cancel chair movement
Warranty	5 Year Limited

Standard Features:

- Independent backrest
- Articulating dual axis headrest
- Solid steel base
- Programmable foot control

Laguna 2.0

Electromechanical Patient Chair

Description

Model

Suggested Retail Price

Laguna 2.0 Electromechanical Patient Chair

#L2000-2.0

Packages include the following:

Two programmable positions
 One preset exit position
 Electronic foot control with auto return function
 Built-in fuse / surge protection
 Toe guard protection to prevent scuffing
 All-metal construction
 Double articulating headrest, adjustable for height and wheelchair positioning
 Seamless Upholstery
 Input voltage 110V or 220V



Optional: TP-2005 Touch pad control installed on dental chair



Model#L2000-2.0

Packing Dimensions (L x W x H)	Weight
Chair: 44 x 29 x 33	340 lbs.
Cushion: 51 x 24 x 10	35 lbs.

Options: "Options are not factory-installed unless specified on the purchase order. Additional charges apply."

Retail

TP-2005	Touch pad control – Unit mounted, 3 preset, auto return, last position
PC-5000-DU	Upcharge Dental Chair Upholstery-Wide Back Duration Vinyl- Specify Color and Product Code
PC-5000-Vinyl-UC	Upcharge Non-Standard Dental Chair Upholstery-Wide Back Vinyl- Specify Color and Product Code
PC-5000-ULTR-UC	Upcharge Ultra leather Dental Chair Upholstery-Wide Back Ultra leather- Specify Color and Product Code
LAGBRKT	Laguna Post mount chair bracket

Laguna 2.0

Chair Mounted Operatory System

LP2100-550LED-2.0



Optional
MO17 LCD Monitor

#L550-LED

2000-2.0

TP-2005

#L2000-2.0

Packing Dimensions (L x W x H)	Weight
Chair: 44 x 29 x 33	340 lbs.
Cushion: 51 x 24 x 10	35 lbs.
Unit: 39 x 29 x 23	60 lbs.
Unit: 43 x 25 x 12	40 lbs.
Dental Light: 34 x 11 x 5	30 lbs.
Light Head: 12 x 15 x 7	
Cuspidor 20 x 13 x 14	20 lbs.

Laguna 2.0

Chair Mounted Operatory System

Description	Model	Suggested Retail Price
Laguna 2.0 Operatory Package with Cuspidor	LP2100-550LED-2.0	
Laguna 2.0 Operatory Package with Assistant's Instrumentation		LP2115-550LED-2.0
Packages include the following:	(with cuspidor)	(without cuspidor)
L2000-2.0 Electromechanical patient chair with wide back and full lumbar support, rotating armrests left or right, double articulating headrest with sliding height adjustment, 3 programmable positions with automatic return and foot control	✓	✓
2015-2.0 Asepsis 3 Handpiece automatic control with coolant controls, flex arm with air brake, diaphragm block design, wet/dry variable speed foot control, deluxe utility center with air /water filters and regulators, master shut off valves. Includes 3 way syringe and light post with cutout for internal wires and monitor bracket Asepsis rotating 4 position assistant's package, Hve and saliva ejector, water disconnect solids collector and clean water system. With Touch pad control.	✓	✓
L550-LED Lustrous LED post mounted light with adjustable intensity, 8,000-30,000 Lux	✓	✓
2000-2.0 Porcelain cuspidor with timed bowl rinse and cup filler, rotating 4 position assistant's package, Hve and saliva ejector, water quick disconnect, solids collector and clean water system With Touch pad control.	✓	

Options: "Options are not factory-installed unless specified on the purchase order. Additional charges apply." Retail

TPC3WAY-PRT	Additional autoclavable 3 way syringe with tubing
P2335+TB	Deluxe autoclavable Hve Long valve with tubing
WIC800	Standard flat screen monitor bracket
WIC825	Deluxe flat screen monitor bracket with 16" extension
WIC840	Mirage flat screen monitor bracket with 16" extension
MO17	17" LCD multi media flat screen monitor
A800N-1	Advance 800 piezo scaler – built in
H7000	Illumination System – ISO B (5 hole) – tubing, control box, bulb, power supply
H7040	Illumination handpiece tubing – 5 hole
H7070-LED	Fiber optic bulb cartridge
H7660	Illumination System- ISO C (6 pin) – tubing, control box, power supply
H7045	Illumination handpiece tubing- 6 pin
ALED55BN-A	LED 5W curing light – built in to dental unit
TP-2005	Touch pad control – unit head or dental chair mounted 3 preset, auto return, last position
53016-L-100	Disposable Solids Collector Trap, 2 1/8' (pack of 100)
2000-C-2.0	Mirage Cuspidor with touch pad control
TPE-2011	Touch pad Control - Chair & Electric Motor System touch pad
EMB-901	Built in Electric Motor System
XV100	Super thin X-ray film viewer
XV150-R	X-ray film viewer bracket (curved) for TPC Mirage unit only
AS-1101	Mirage Assistants stool
DR-1102	Mirage doctor's stool

Laguna 2.0

Orthodontic Package

Standard Features:

- Independent backrest
- Articulating dual axis headrest
- Steel base
- Armrests rotate in and out
- Programmable foot control
- Short pump cover
- Electric motor operated

Standard Features:

- Intergrated non cure mode
- 24V DC power Supply
- Bulb type: 4 White LEDs 2 Yellow
- Light intensity (Lux):
High 30,000;
Low 8,000
- Focal length: 27" (70 cm)
- Illumination area: 100mm x180mm
- Sensor mode only

Standard Control Features:

- 3 HP Automatic selection
- 3-way Syringe
- Vacuum package with saliva ejector and hve
- Self contained water bottle system
- wet / dry foot control
- 1 Year warranty
- Requires central Air / vacuum systems
- Includes utility center and junction box

LOP2000-L550LED-2.0



Optional OMC 2200
Monitor Bracket



Pull out writing
surface

Standard Cabinet Features:

- Five easy to remove and clean full extension drawers, and one pull-out writing surface.
- High quality hardware throughout
- Oversized caster wheels with locks
- A removable counter - top plastic tray
- Standard 12" X 12" Junction Box
- 7' Length of umbilical

Rear cabinet
door view

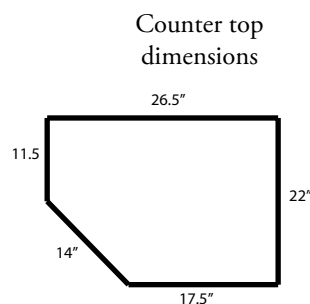

Packing Dimensions (L x W x H)	Weight
Chair: 44 x 29 x 33	340 lbs.
Cushion: 52 x 24 x 10	35 lbs.
Light Arm: L600 26 x 14 x 8	30 lbs.
Light Head: L550 17 x 15 x 7	
Cabinet 32 x 28 x 41	140 lbs.

Laguna 2.0

Orthodontic Package

Description	Model	Suggested Retail Price
-------------	-------	------------------------

Laguna 2.0 Orthodontic Package	LOP2000-L550LED-2.0	
--------------------------------	---------------------	--

Packages include the following:

L2000-2.0 Electromechanical patient chair with wide back and full lumbar support, double articulating headrest with sliding height adjustment, 3 programmable positions with automatic return and foot control	✓
--	---

OMC-2375 This orthodontic mobile delivery cabinet offers a pullout writing surface, two instrument drawers, one medium and two large storage drawers for materials and supplies that fully extend and quickly remove for easy cleaning. In addition, these cabinets provide a large open space for accessories with convenient access from the front. Oversized locking dual-casters.	✓
---	---

L550-LED Lustrous LED post mounted light with dual intensity, 8,000 - 30,000 LUX, dual axis light head rotation	✓
---	---

LAGBRKT The chair bracket is included at no charge (value: \$290) when purchasing the Laguna Orthodontic Package	✓
--	---

Options: "Options are not factory-installed unless specified on the purchase order. Additional charges apply."

Retail

WIC840	Mirage flat screen monitor bracket with 16" extension
MO17	17" LCD multi media flat screen monitor
H7000	Illumination System – ISO B (5 hole) – tubing, control box, bulb, power supply
H7660	Illumination System – ISO C (6 pin) – tubing, control box, power supply
ALED55BN-A	LED 5W curing light – built in to dental unit
TP-2005	Touch pad control – dental chair mounted 3 preset, auto return, last position
OMC2200	LCD monitor bracket
53016-L-100	Disposable Solids Collector Trap 2 1/8" (Pack of 100)
OMC-ST81	Optional Stone Surface on OMC 2375, Color Artic
OMC-ST82	Optional Stone Surface on OMC 2375, Color White
OMC-ST85	Optional Stone Surface on OMC 2375, Color Cream
OMC-ST86	Optional Stone Surface on OMC 2375, Color Bamboo
LAGBRKT	Laguna Post mount chair bracket
AS-1101	Mirage Assistants stool
DR-1102	Mirage doctor's stool

Optional: Stone Counter top
OMC-ST81

Optional: Stone Counter top
OMC-ST82

Optional: Stone Counter top
OMC-ST85

Optional: Stone Counter top
OMC-ST86



Mirage 2.0

Chair Mounted Delivery System



Standard Features

- Asepsis automatic control for three handpieces
- Individual handpiece pressure adjustments
- Non-retracting water coolant with on/off
- Individual water coolant flow controls
- Air coolant flow control
- Handpiece tubing flush system
- Ultra soft handpiece tubing
- 6-pin straight gray asepsis tubing with Midwest connector. (5-Hole tubing optional)
- Disc foot control wet/dry toggle with 7' of smooth tubing
- Equipment utility center with asepsis housing
- Vacuum canister with solids collector screen
- Water quick disconnect
- Self contained water system with city/bottle selector switch
- Straight light post for unit mount dental light
- Pre-wiring for fiber optic light source
- Air-actuated counterbalanced arm lock
- 3 way syringe on unit head
- Touch pad control

Model #2000-2.0

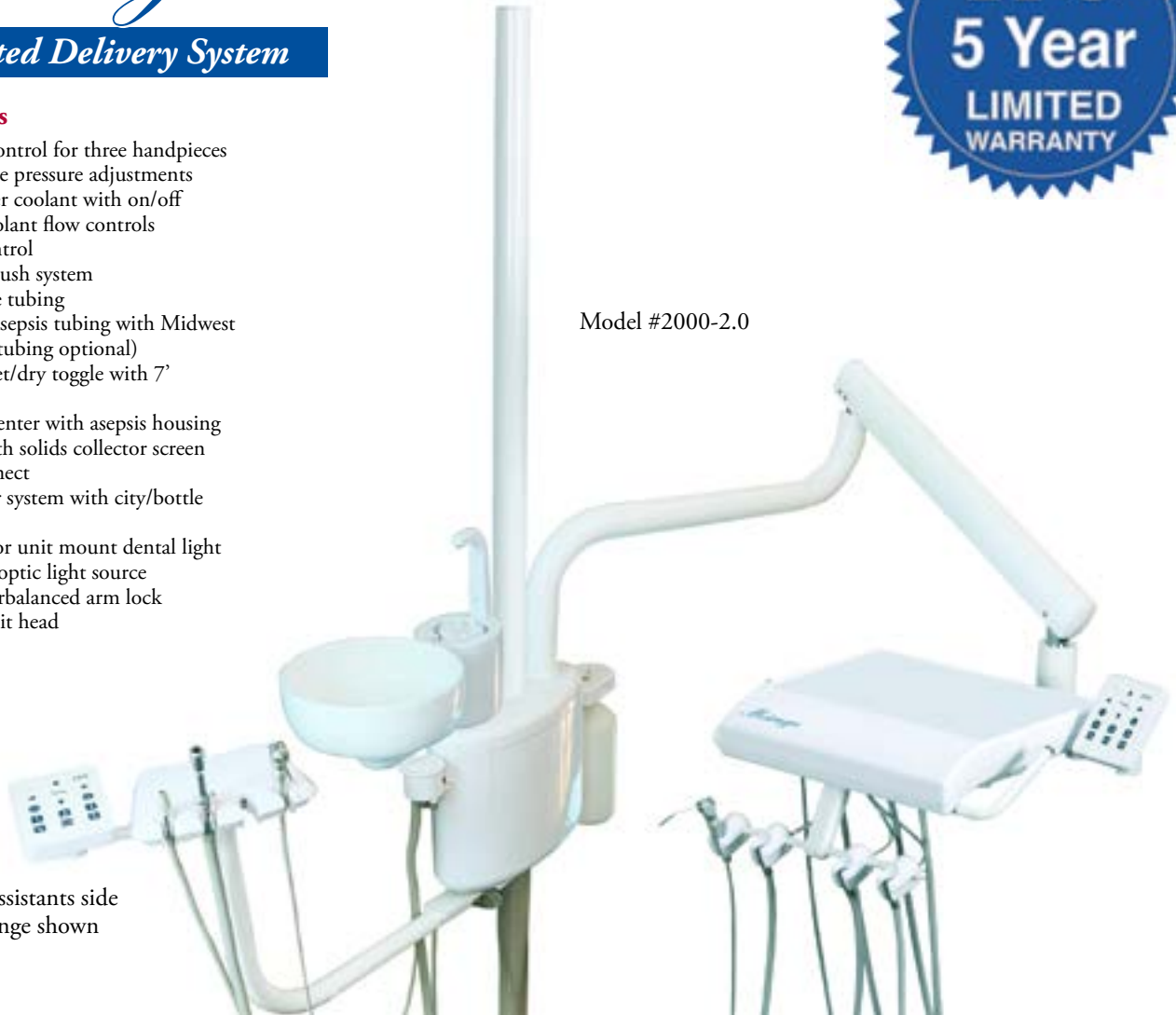

Optional: Assistants side 3-way syringe shown

Gravity Drain Cuspidor

- Contoured bowl is made of fine porcelain for easy cleaning and infection control.
- The cuspidor operates with a timed bowl rinse and cup filler
- Swing away cuspidor bowl
- Electric solenoid water flow controlled
- Touch pad control



Control Head: Easy access controls for simple adjustments. Ultra soft handpiece tubing minimizing hand and wrist stress.



Cuspidor Bowl: The deep contoured bowl is made of fine porcelain for easy cleaning and infection control.



Optional: Multi media flat screen monitor for chair side intraoral imaging, patient education and DVD viewing.

Assistant's Instrumentation on Rotating Arm

- 1 autoclavable HVE with asepsis tubing
- 1 autoclavable saliva ejector with asepsis tubing
- Optional Assistants side 3-way syringe



Built in self contained 1500ml water bottle system including city/bottle selector switch.



Optional: Assistants side 3-way syringe



Built in water quick disconnect for ultrasonic scaling.

Options

- Built In Electric Handpiece
- Built-in Led curing light
- Built-in scaler
- Illumination light source
- Post-mounted utility tray
- 17" LCD Monitor
- LCD monitor bracket

Mirage 2.0

Chair Mounted Delivery System

Model #2015-2.0

Optional: Assistants side
3-way syringe shown



Optional: TP-2005
Touchpad control



Optional: TPE-2011
Touchpad control

Packing Dimensions (L x W x H)	Weight
Unit: 39 x 29 x 23	60 lbs.
Unit PMU: 43 x 25 x 12	40 lbs.
Cuspidor: 26 x 18 x 10	20 lbs.

Description

Mirage 2.0 Chair Mounted Delivery System with Cuspidor
Mirage 2.0 Chair Mounted Delivery System

Model

2000-2.0

Suggested Retail Price

2015-2.0

Package includes the following:

(with cuspidor)

(without cuspidor)

Asepsis 3 handpiece automatic control with coolant controls, flex arm with dual air brake, tri block design, wet/dry variable speed foot control, deluxe utility center with air /water filters and regulators, master shut off valves. Includes 3 way syringe and light post with cutout for internal wires and monitor bracket, 7' umbilical with touch pad control



Porcelain cuspidor with sensor controlled bowl rinse and cup filler, rotating 4 position assistant's package, Hve and saliva ejector, water quick disconnect, solids collector and clean water system with touch pad control



Rotating 4 position assistant's package, Hve and saliva ejector,



water quick disconnect, solids collector and clean water system, light Post



Options: "Options are not factory-installed unless specified on the purchase order. Additional charges apply."

Retail

TPC3WAY-PRT	Additional autoclavable 3 way syringe with tubing
P2335+TB	Deluxe autoclavable Hve valve with tubing
WIC800	Standard flat screen monitor bracket
WIC825	Deluxe flat screen monitor bracket with 16" extension
WIC840	Mirage flat screen monitor bracket with 16" extension
#MO17	17" LCD multi media flat screen monitor
A800N-1	Advance 800 piezo scaler – built in
H7000	Illumination System – ISO B (5 hole) – tubing, control box, bulb, power supply
H7660	Illumination System – ISO C (6 pin) – tubing, control box, power supply
ALED55BN-A	LED 5W curing light – built in
L600-LED	Lucent LED Operatory Light
L550-LED	Lustrous LED Operatory Light "with motion sensor, with manual toggle"
BELBRKT	BLMT chair mount bracket BLMT chair mount bracket (20 / 50)
TPCBRKT	TPC chair mount bracket
TP-2005	Touch pad control – unit head or dental chair mounted, 3 preset, auto return, last position
TPE-2011	Touch pad Control - Chari & Electric Motor System touch pad
53016 -L-100	Disposable Solids Collector Trap, 2 1/8" (pack of 100)
2000-C-2.0	Mirage Cuspidor
EMB-901	Built In Electric Motor system
XV100	Super Thin X-ray Viewer
XV150-R	Xray viewer bracket (round cut-out) – mount to Mirage unit head (Round Arm)

Bellagio

Chair Mounted Delivery System



Standard Features

- Asepsis automatic control for three handpieces
- Individual handpiece pressure adjustments
- Non-retracting water coolant with on/off
- Individual water coolant flow controls
- Air coolant flow control
- Handpiece tubing flush system
- Ultra soft handpiece tubing
- 5-Hole straight gray asepsis tubing with Midwest connector.
- Disc foot control wet/dry toggle with 7' of smooth tubing
- Equipment utility center with asepsis housing
- Vacuum canister with solids collector screen
- Water quick disconnect
- Self contained water system with city/bottle selector switch
- Straight light post for unit mount dental light
- Pre-wiring for fiber optic light source
- Air-actuated counterbalanced arm lock
- 3 way syringe on unit head
- Intergrated touch pad control
- Intergrated piezo scaler
- Intergrated timer

Model #5000-2.0



Optional: Assistants side 3-way syringe shown

Gravity Drain Cuspidor

- Contoured bowl is made of fine porcelain for easy cleaning and infection control.
- The cuspidor operates with a timed bowl rinse and cup filler
- Swing away cuspidor bowl
- Electric solenoid water flow controlled
- Touch pad control



Control Head: Easy access controls for simple adjustments. Ultra soft handpiece tubing minimizing hand and wrist stress.



Cuspidor Bowl: The deep contoured bowl is made of fine porcelain for easy cleaning and infection control.



Optional: Multi media flat screen monitor for chair side intraoral imaging, patient education and DVD viewing.

Assistant's Instrumentation on Rotating Arm

- 1 autoclavable HVE with asepsis tubing
- 1 autoclavable saliva ejector with asepsis tubing
- Optional Assistants side 3-way syringe



Built in self contained 1500ml water bottle system including city/bottle selector switch.



Optional: Assistants side 3-way syringe



Built in water quick disconnect for ultrasonic scaling.

Options

- Built In Electric Handpiece
- Built-in Led curing light
- Illumination light source
- Post-mounted utility tray
- 17" LCD Monitor

Bellagio

Chair Mounted Delivery System

Model #5000-2.0

Optional: Assistants side
3-way syringe shown



Packing Dimensions (L x W x H)	Weight
Unit: 39 x 29 x 23	60 lbs.
Unit PMU: 43 x 25 x 12	40 lbs.
Cuspidor: 26 x 18 x 10	20 lbs.

Description

Bellagio Chair Mounted Delivery System with Cuspidor
Bellagio Chair Mounted Delivery System

Model

5000-2.0

Suggested Retail Price

5015-2.0

Package includes the following:

(with cuspidor)

(without cuspidor)

Asepsis 3 handpiece automatic control with coolant controls, flex arm with dual air brake, tri block design, wet/dry variable speed foot control, deluxe utility center with air /water filters and regulators, master shut off valves. Includes 3 way syringe and light post with cutout for internal wires and monitor bracket, 7' umbilical with touch pad control

✓

✓

Porcelain cuspidor with sensor controlled bowl rinse and cup filler, rotating 4 position assistant's package, Hve and saliva ejector, water quick disconnect, solids collector and clean water system with touch pad control

✓

✓

Rotating 4 position assistant's package, Hve and saliva ejector,

✓

water quick disconnect, solids collector and clean water system, light post

✓

✓

Options:

TPC3WAY-PRT	Additional autoclavable 3 way syringe with tubing
P2335+TB	Deluxe autoclavable Hve valve with tubing
WIC800	Standard flat screen monitor bracket
WIC840	Mirage flat screen monitor bracket with 16" extension
#MO17	17" LCD multi media flat screen monitor
H7000	Illumination System – ISO B (5 hole) – tubing, control box, bulb, power supply
H7660	Illumination System – ISO C (6 pin) – tubing, control box, power supply
ALED55BN-A	LED 5W curing light – built in
L600-LED	Lucent LED Operatory Light
L550-LED	Lustrous LED Operatory Light "with motion sensor, with manual toggle"
BELBRKT	Belmont chair mount bracket (Bel 20/Bel 50)
TPCBRKT	TPC chair mount bracket
TP-2005	Touch pad control – unit head or dental chair mounted, 3 preset, auto return, last position
TPE-2011	Touch pad Control - Chari & Electric Motor System touch pad
53016 -L-100	Disposable Solids Collector Trap, 2 1/8" (pack of 100)
2000-C-2.0	Mirage Cuspidor
EMB-901	Built In Electric Motor system
XV100	Super Thin X-ray Viewer
XV150-R	Xray viewer bracket (round cut-out) – mount to Mirage unit head (Round Arm)

Mirage 2.0 - BLMT

Swing Mount Delivery System

Model #2450-2.0

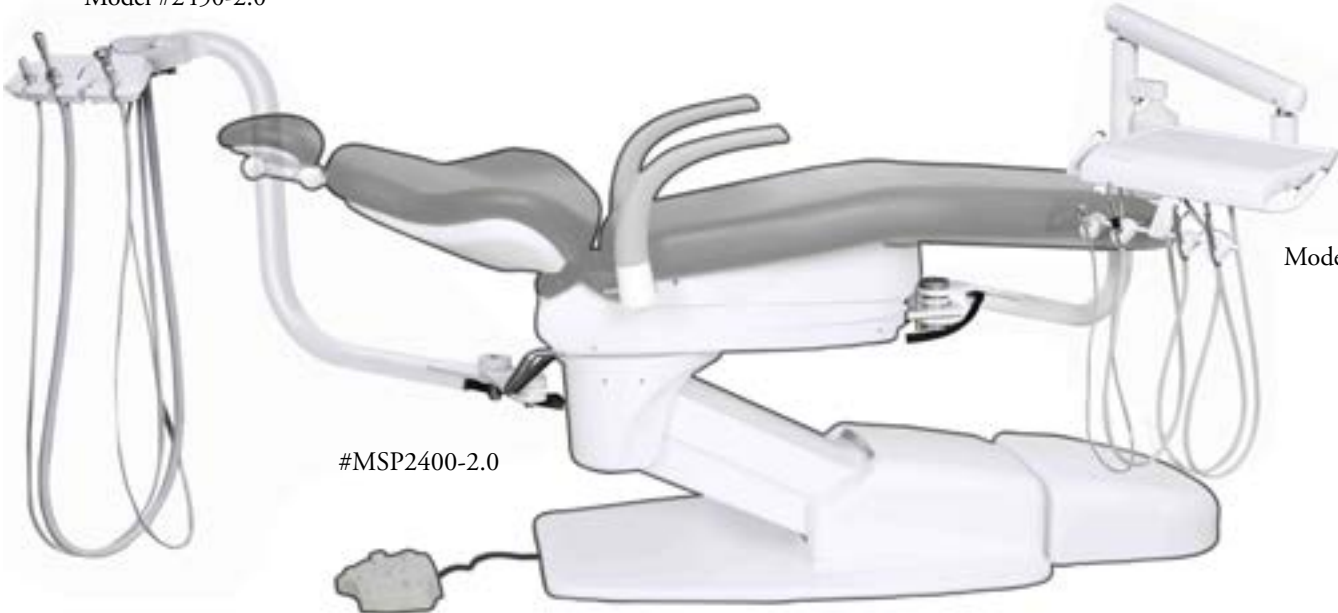

Model #2400-2.0

#MSP2400-2.0

- Compatible with BLMT 7, 10, 20, 20N, 50 Patient Chairs



Optional: LP100 swing mount light post with optional L550-LED Operator Light

Packing Dimensions (L x W x H)	Weight
Chair: 44 x 29 x 33	340 lbs.
Cushion: 51 x 24 x 10	35 lbs.
3500: 36 x 28 x 39	100 lbs.
3550: 29 x 12 x 24	25 lbs.
LP100: 45 x 26 x 44	30 lbs.

Mirage 2.0-BLMT

Swing Mount Delivery System

Description	Model	Suggested Retail Price
-------------	-------	------------------------

Mirage 2.0 BLMT Swing Mount Delivery System (Unit + Asst pkg)	MSP2400-2.0	
---	-------------	--

Packages include the following:

2400-2.0	Rotating asepsis 3 Handpiece automatic control with coolant controls, flex arm with air brake, diaphragm block design, wet/dry variable speed foot control, deluxe utility center with air /water filters and regulators, master shut off valves. Includes 3 way syringe and clean water system,	* Fits 7, 10, 20, 20N, 50
2450-2.0	Rear radius asepsis assistant's arm system, Hve and saliva ejector, water quick disconnect and solids collector * Specify * Fits 7, 10, 20, 20N, 50 chair at time of order	

Options: "Options are not factory-installed unless specified on the purchase order. Additional charges apply."

Retail

2400-2.0	BLMT- TPC Swing Mount Delivery System-	7, 10, 20, 20N, 50
2450-2.0-O	BLMT- TPC Rear Radius Vacuum Pkg-	20N, 50
2450-2.0-U	BBLMT-TPC Rear Radius Vacuum Pkg-	7, 10, 20
2450-BRKT-BEL-N	BLMT-TPC Rear Radius Bracket ONLY-	20N, 50
2450-BRKT-BEL	BLMT-TPC Rear Radius Bracket ONLY-	7,10,20
BELBRKT	BLMT Chair Mount Bracket	
2400-BRKT-BEL	BLMT- TPC Radius Chair Bracket ONLY-	7, 10, 20, 20N, 50
BEL20N-FC	BLMT Foot Control-	20N, 50
BEL20-FC	BLMT Foot Control-	7,10,20
LP-100	Mirage swing mount light post (ordered w/unit)	
LP-105	Mirage swing mount monitor post with monitor mounting bracket (ordered w/unit)	
L600-LED	Lucent LED Operatory Light	
L690-LED	Lucent LED Ceiling Mounted Operatory Light	
L550-LED	Lustrous LED Operatory Light	
TPC3WAY-PR T	Additional autoclavable 3 way syringe with tubing	
P2335+TB	Deluxe autoclavable Hve Long valve with tubing	
WIC800	Standard flat screen monitor bracket	
WIC825	Deluxe flat screen monitor bracket with 16" extension	
WIC840	Mirage flat screen monitor bracket with 16" extension	
MO17	17" LCD multi media flat screen monitor	
A800N-1	Advance 800 piezo scaler – built in	
H7000	Illumination System – ISO B (5 hole) – tubing, control box, bulb, power supply	
H7040	Illumination handpiece tubing – 5 hole	
H7070-LED	Fiber optic bulb cartridge	
H7660	Illumination System – ISO C (6 pin) – tubing, control box, power supply	
H7045	Illumination handpiece tubing – 6 pin	
ALED55BN-A	LED 5W curing light – built in to dental unit	
XV100	Super thin X-ray film viewer	
XV150-R	X-ray film viewer bracket (curved) for TPC Mirage Unit only	

BLMT

BLMT Compatible Components



#2450-BRKT-BEL
 • Fits BLMT Chairs 7, 10, 20
 • Includes bolt / washer set



#2450-BRKT-BEL-N
 • Fits BLMT Chairs 20N, 50
 • Includes bolts / washer kit



#BELBRKT
 • Fits BLMT Chairs
 • Includes bolts / washer set



#2400-BRKT-BEL
 • Fits BLMT Chair 7,10, 20, 20N, 50
 • Includes bearing / washer kit
 • Used to mount TPC swing unit to belmont chair



Square Connector

#BEL20-FC
 • Fits BLMT Chairs 7, 10, 20
 • Includes wire harness



Flat Connector

#BEL20N-FC
 • Fits BLMT Chairs 20N, 50
 • Includes wire harness

Description

BLMT-TPC Radius Chair Bracket. Fits 7, 10, 20, 20N, Bel 50
 BLMT-Chair Mount Bracket
 BLMT-Chair Foot Control. Fits 7,10, 20
 BLMT-Chair Foot Control. Fits 20N, 50
 BLMT-TPC Rear Radius Bracket only 7, 10, 20
 BLMT-TPC Rear Radius Bracket only 20N, 50
 BLMT-TPC Rear Radius Vacuum Pkg- 7, 10, 20
 BLMT-TPC Rear Radius Vacuum Pkg- 20N, 50

Model

2400-BRKT-BEL
 BELBRKT
 BEL20-FC
 BEL20N-FC
 2450-BRKT-BEL
 2450-BRKT-BEL-N
 2450-2.0-U
 2450-2.0-O

Suggested Retail Price

Mirage 2.0

Mirage 2.0 Mobile Doctors Cart



Model #MC-501-2.0

Model #MC-500-2.0

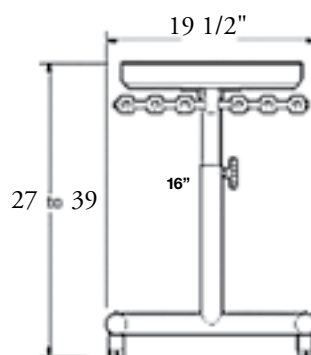

Description	Model	Suggested Retail Price
-------------	-------	------------------------

Mirage 2.0 Mobile Doctors Cart	MC-500-2.0	
Mirage 2.0 Mobile Doctors Cart with Vacuum Package	MC-501-2.0	
Asepsis 3 handpiece automatic selection with bottle system	✓	✓
3 way syringe with quick change autoclavable tip	✓	✓
Master on/off toggle	✓	✓
Air / Water pressure adjustment for each handpiece	✓	✓
Pressure gauge	✓	✓
Non-retracting water / air coolant adjustment and purge	✓	✓
Asepsis handpiece tubing	✓	✓
Painted H-frame with height adjustment, 27" to 39"	✓	✓
Vacuum canister with removable screen 2 1/8"		✓
1 autoclavable Hve and saliva ejector and tubing		✓
Variable speed foot control	✓	✓
10 feet of umbilical	✓	✓

Options: "Options are not factory-installed unless specified on the purchase order. Additional charges apply."

H7000	Illumination System – ISO B (5 hole) – tubing, control box, bulb, power supply	
H7660	Illumination System – ISO C (6 pin) – tubing, control box, power supply	
A800N-1	Advance 800 N piezo scaler – built in	
53016-L-100	Disposable Solids Collector Trap, 2 1/8" Pk of 100	
MC500-UMB-FT	Additional Umbilical Per Foot	
MC501-UMB-FT	Additional Umbilical Per Foot	

Retail

Model #MC-501-2.0

Model #MC-500-2.0

Packing Dimensions: 29" x 23" x 21" / 50 lbs

Packing Dimensions: 29" x 23" x 21" / 50 lbs

Mirage

Panel & Cabinet Mount Systems



Model #MP-2600
Mirage Panel Mount
Rear Delivery System



Model #MP-2601
Mirage Wall / Cabinet Mount
Rear Assistants package



Mirage Rear Cabinet Mount
Delivery System with Assistants Package

Standard Features

- 2 Handpiece Tubing Positions
- 3 Position HP Holder
- TPC Press ring style syringe
- Individual drive air & water coolant controls
- Foot control
- Control Dimensions 8 1/2" x 1 3/4" x 5"
- Cut-out dimensions 7 1/2" x 11 1/2"
- Syringe has adjustable air & water controls
- Air / Water master control with Regulator.

Standard Features

- 2 HVE Suciton Valves
- 1 SE Suction Valve
- 3 Position Suction Holder
- Vacuum canister with removable screen

Standard Features

- Asepsis 3 handpiece automatic selection with bottle system
- 3 way syringe with quick change autoclavable tip
- Master on/off toggle
- Air / Water pressure adjustment for each handpiece
- Pressure gauge
- Non-retracting water / air coolant adjustment and purge
- Asepsis handpiece tubing
- Asepsis flex arm system, w/ 9" rigid arm, pneumatic brake
- Self contained bottle system
- Stainless Steel tray
- 3 way syringe with quick change autoclavable tip
- Utility center
- Vacuum canister with removable screen

Description

Model

Suggested Retail Price

Mirage Panel Mount Rear Delivery System (2 HP manual select, 3-Way Syringe, 3 position HP holder, Utility Valves)	MP-2600	
Mirage Wall & Cabinet Mount Assistance Package (2 HVE, 1 SE, 3 position holder)	MP-2601	

Options: "Options are not factory-installed unless specified on the purchase order. Additional charges apply." Retail

H7660	Illumination system – ISO C (6 pin) – tubing, control box
H7000	Illumination system – ISO B (5 hole) – tubing, control box, bulb
A800N	Advance 800 piezo scaler – built in
P2335+TB	Deluxe autoclavable Hve valve with tubing
53016-S-100	Disposable Solids Collector Trap, 1 7/8" (Pack of 100)
53016-L-100	Disposable Solids Collector Trap, 2 1/8" (Pack of 100)

Packing Dimensions: 9" x 17" x 15" / 9 lbs
MP-2600

Packing Dimensions: 8" x 17" x 15" / 5 lbs
MP-2601

Packing Dimensions: 19" x 15" x 20" / 30 lbs
MP-4500



Mirage

Wall / Cabinet Mounted System

Model #MS-3000

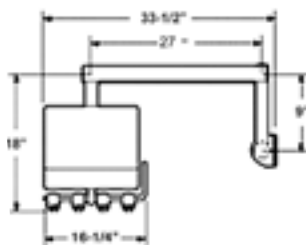

Model #MR-4000.2.0

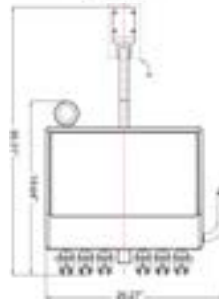

Model #MVP-5000-2.0

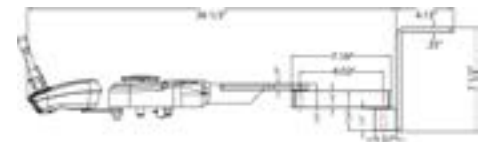

Suggested Retail Price

	MS-3000	MR-4000.2.0	MVP-5000.2.0
Mirage Cabinet Mounted Side Delivery Unit			
Mirage Cabinet Mounted Rear Delivery Unit			
Mirage Cabinet Mounted Vacuum Package			
Asepsis 3 handpiece automatic selection with bottle system	✓	✓	
3 way syringe with quick change autoclavable tip	✓	✓	
Master on/off toggle	✓	✓	
Air / Water pressure adjustment for each handpiece	✓	✓	
Pressure gauge	✓	✓	
Non-retracting water / air coolant adjustment and purge	✓	✓	
Asepsis handpiece tubing	✓	✓	(39" reach, 19" vertical)
Asepsis flex arm system, w/ 9" rigid arm, pneumatic brake	✓	✓	
2" diameter wall bracket	✓		(22" reach)
Pivoting arm mounted vacuum canister w/ screen			✓
3 way syringe with quick change autoclavable tip			✓
Water quick disconnect			✓
Vacuum canister with removable screen			✓
4 position holder, 1 autoclavable Hve and saliva ejector & tubing			✓
Variable speed foot control	✓	✓	

Options:

Retail

H7660	Illumination system – ISO C (6 pin) – tubing, control box
H7000	Illumination system – ISO B (5 hole) – tubing, control box, bulb
A800N	Advance 800 piezo scaler – built in
P2335+TB	Deluxe autoclavable Hve valve with tubing
53016-L-100	Disposable Solids Collector Trap, 2 1/8" (Pack of 100)

Packing Dimensions: 17" x 21" x 51" / 60 lbs
MS-3000

Packing Dimensions: 19" x 15" x 20" / 25 lbs
MR-4000

Packing Dimensions: 13" x 24" x 11" / 15 lbs
MVP-5000

OMC 2375

Orthodontic Mobile Delivery Cabinet



Optional OMC 2200
Monitor Bracket



Rear compartment
4" W X 12"D X 20" H

Function:

This orthodontic mobile delivery cabinet offers a pullout breadboard, two instrument drawers, one medium and two large storage drawers for materials and supplies that fully extend and quickly remove for easy cleaning. In addition, these cabinets provide a large open space for accessories with convenient access from the front. The oversized dual-caster wheels, makes positioning of the cabinet simple and easy on all floor surfaces, including carpet.

Standard Cabinet Features:

- Five easy to remove and clean full extension drawers, and one pull-out writing surface.
- High quality hardware throughout
- Oversized caster wheels with LOCKS
- Four stationary handles for easy cart positioning
- A removable counter - top plastic tray
- Standard 12" X 12" Junction Box
- 7' Length of umbilical



OMC2375

Writing surface with
optional solid surface



Artic

OMC-ST81



White

OMC-ST82

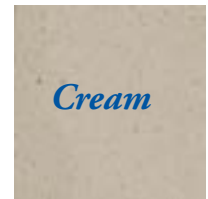

Cream

OMC-ST85



Bamboo

OMC-ST86

Optional hard surface stone top

Standard Control Features:

- 3 HP Automatic selection
- 3-way syringe
- Vacuum Package with Saliva Ejector and HVE
- Self contained water bottle system
- Variable speed disc-type foot control
- Water coolant on/off switch with flow control
- 1 Year warranty
- Includes Utility center + junction box
- Requires central air and vacuum connections

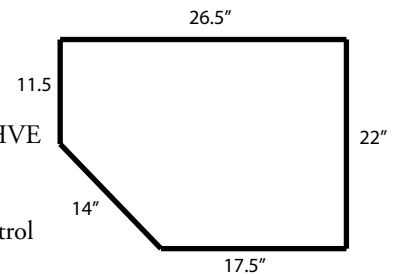

Description

Orthodontic Mobile Delivery Cabinet

Model

OMC2375

Suggested Retail Price

Options: "Options are not factory-installed unless specified on the purchase order. Additional charges apply."

A800N-1	Advance 800N Piezo Scaler - Built in
ALED55BN-A	LED 55BN 5W LED Curing Light -Built in
2375-UMB-FT	Umbilical Per Foot
OMC2200	LCD Monitor Bracket W/ Post
OMC-ST81	Optional Stone Surface on OMC 2375, Color Artic
OMC-ST82	Optional Stone Surface on OMC 2375, Color White
OMC-ST85	Optional Stone Surface on OMC 2375, Color Cream

Retail

Packing Dimensions: 41" x 28" x 32" / 140 lbs



DC6112D/A



DC6224D/A



Superb Air Oil-less Air Compressor

The TPC Superb Air Oil-less Air Compressors meet the high standards of the dental professionals, providing the reliability you need from a brand you can trust. The new motor design delivers a reduced noise with a 5-year warranty. The **desiccant air drying system** efficiently filters out compressed air contaminants and moisture from the compressed air. Purge tank removes residual humidity in the compressor following each cycle.

Model	DC6112D/A	DC6122D/A	DC6214/DA	DC6224D/A	DC6326D/A	DC6228D/A
User Capacity	1-3users	1-3users	3-4users	5users	6-7users	8-9users
CDFM@80psi	4.9	4.9	9.8	9.8	14.7	19.6
# of Heads	1	1	2	2	3	2
Total HP	1.15	1.15	2.30	2.30	3.45	4.80
Voltage	110V	230V	110V	230V	230V	230V
Amps	8	4	16	8	12	16
Breaker Amps	20	20	30	20	30	30
dBA	62	62	62	62	72	72
Tank Capacity	10 Gallon	10 Gallon	16 Gallon	16 Gallon	23 Gallon	30 Gallon
Size (HxWxD)	16x23x27	16x23x27	26x21x29	26x21x29	34x22x29	41x22x36
Shipping Dimension (WxDxH)	29x23x35	29x23x35	34x26x35	34x26x35	39x25x38	46x27x41

Features:

- New motor design to reduce noise and increase reliability
- Quiet operation
- Dry air prevents bacteria growth and air if filtered to 0.01 micron keeping 99.9997% of air contaminants out of your air system
- Energy efficient thermally protected motors
- Superb Air Oil-less compressors are available in single or twin heads
- **Desiccant air drying system to remove moisture from compressed air**
- **5-year warranty**

Description

Model

Superb Air Compressor, 1.15 HP, 110V	DC6112
Superb Air Compressor, 1.15 HP, 230V	DC6122
Superb Air Compressor, 2 x 1.15HP, (2.3HP) 110V	DC6214
Superb Air Compressor, 2 x 1.15HP, (2.3HP) 230V	DC6224
Superb Air Compressor, 3 x 1.15HP (3.45HP)230V	DC6326
Superb Air Compressor, 2 x 2.4 HP, (4.8HP)230V	DC6228

Options

Control Panel – 2 Button- 1 Vac / 1 Air	#CP2AV
Control Panel – 3 Button- 1 Vac / 1Air / 1 Water	#CP3
Control Panel – 3 Button- 2 Vac / 1 Air	#CP3AV
Control Panel – 4 Button- 2 Vac / 1 Air / 1 Water	#CP4
Air Compressor and Vacuum Pump Stacking Rack	#CV22

Maintenance kits for

	Model
DC 6112 / 6122 (air filter, desiccant filter, 5 micron filter)	DC6-PM1
DC 6214 / 6224 (air filter, desiccant filter, 5 micron filter)	DC6-PM2
DC 6226 (air filter, desiccant filter, 5 micron filter)	DC6-PM3
DC 6228 (air filter, desiccant filter, 5 micron filter)	DC6-PM4

SuperbAIR air compressors not to be used for CAD / 3D printers

Shipping Dimensions: L X W X H

DC6112: 29" X 23" X 35"
DC6122: 29" X 23" X 35"
DC6214: 34" X 26" X 35"
DC6224: 34" X 26" X 35"
DC6326: 39" X 25" X 38"
DC6228: 46" X 27" X 41"

Superb Vac

Wet-Ring Vacuum



Model	WV3 (Single)	WV5 (Single)	WV6(Twin)	WV10 (Twin)
Water consumption without water recycling:	4L/min	4L/min	6L/min	6L/min
Water consumption with TPC water recycling:	.8L/min	.8L/min	1.0L/min	1.0L/min
Suction Rate	900L/min	1500L/min	1800L/min	3000L/min
Vacuum Level (1N Hg) Factory set to 10HG	8-15 HG	8-15 HG	8-15 HG	8-15 HG
Noise Level dB (A)	58	58	65	65
Horse Power	1 HP	2 HP	2 HP	4 HP
Voltage (WV3 Must Specify Voltage)	110V or 220V	220V	220V	220V
Frequency (Must specify 50Hz for 220V 50Hz export)	50 / 60Hz	60Hz 50Hz	60Hz 50Hz	60Hz 50Hz
Max. users	3	5	6	10
Current (A)	8A	13A	8Ax2	13Ax2
Circuit Breaker (A)	20A	20A	20Ax2	20Ax2
Inlet Connection Size	3/4"	3/4"	1"	1"
Drain Connection Size	1.25"	1.25"	1.25"	1.25"
City Water Connection Size	3/8"	3/8"	3/8"	3/8"
Air Exhaust Connection Size	2 3/8"	2 3/8"	2 3/8"	2 3/8"
Inlet Water Pressure (PSI)	10Psi / 0.7bar	10Psi / 0.7bar	10Psi / 0.7bar	10Psi / 0.7bar
Ambient Temperature	2 C- 40	2 C- 40	2 C- 40	2 C- 40
Product Size (LxWxH) Inches	16.5x14x18	16.5x14x18	28x17x18	28x17x18
Product Weight (LBS)	62lbs	66lbs	176lbs	198lbs

Features:

- Durable aluminum-bronze construction
- Stainless steel impeller
- Computer balanced, sealed bearings in motor
- Large capacity, easy to clean filter with clear bowl for easy inspection
- Available in single and twin models to accommodate 1-10 users
- 5-year full product limited warranty
- Unique water recycling to save up to 80% water
- UL/CUL classified
- 110V or 220V 50/60 Hz
- 2 3/8" air exhaust connection size
- 20Amp circuit breaker
- Noise level less than < 58 dB
- 3/8" city water connection
- 3/4" inlet connection
- Stainless steel impeller
- NFPA 99C level 3-compliant

Description

Model

Suggested Retail Price

Superb Vac 1HP

WV3(Single) (Specify voltage 110V or 220V when ordering)

Superb Vac 1HP (with recycler)

WV3R(Single)

Superb Vac 2HP

WV5(Single)

Superb Vac 2HP (with recycler)

WV5R(Single)

Product includes the following:

3 Simultaneous users

✓

✓

✓

✓

5 Simultaneous users

✓

✓

Water recycler

✓

✓

220V 50/60Hz

✓

✓

✓

Adjustable vacuum level from 8-15Hg

✓

✓

✓

✓

Options

Model

Suggested Retail Price

#WV-AWS

Single Pump Air/Water Separator

#CP-2AV

Control Panel – 2 Button- 1 Vac / 1 Air

#CP-3

Control Panel – 3 Button- 1 Vac / 1Air / 1 Water

#CP-3AV

Control Panel – 3 Button- 2 Vac / 1 Air

#CP-4

Control Panel – 4 Button- 2 Vac / 1 Air / 1 Water

#CV22

Air Compressor and Vacuum Pump Stacking Rack

Shipping Dimensions:

WV3: 17" x 18" x 20" 65 lbs.

WV5: 17" x 18" x 20" 71 lbs.

Superb Vac

Wet-Ring Vacuum



The TPC Superb Vac wet ring vacuum pump offers a quiet operation for small to medium size dental practices. Our twin TPC Superb Vac wet ring vacuum pump provides vacuum suction when operating in peak work periods. The twin pump offers back-up protection to minimize downtime and costly interruption to work flow.

Standard Features

- 220V 50/60 Hz
- 2 3/8" air exhaust connection size
- 20Amp circuit breaker
- Noise level less than < 58 dB Single
- Noise level less than < 65 dB Twin
- 3/8" city water connection
- 3/4" inlet connection
- Stainless steel impeller
- Unique water recycling to save up to 80% water
- NFPA 99C level 3-compliant
- UL/CUL classified
- 5 year limited warranty

Shipping Dimensions: L" x W: x H"

WV6: 32" x 25" x 24" 188 lbs.

WV6R: 32" x 25" x 24" 188 lbs.

WV10: 32" x 25" x 24" 208 lbs.

Model	WV3 (Single)	WV5 (Single)	WV6 (Twin)	WV10 (Twin)
Water consumption without water recycling:	4L/min	4L/min	6L/min	6L/min
Water consumption with TPC water recycling:	.8L/min	.8L/min	1.0L/min	1.0L/min
Suction Rate	900L/min	1500L/min	1800L/min	3000L/min
Vacuum Level (1N Hg) Factory set to 10HG	8-15 HG	8-15 HG	8-15 HG	8-15 HG
Noise Level dB (A)	58	58	65	65
Horse Power	1 HP	2 HP	2 HP	4 HP
Voltage (WV3 Must Specify Voltage)	110V or 220V	220V	220V	220V
Frequency (Must specify 50Hz for 220V 50Hz export)	50/60Hz	60Hz 50Hz	60Hz 50Hz	60Hz 50Hz
Max. users	3	5	6	10
Current (A)	8A	13A	8Ax2	13Ax2
Circuit Breaker (A)	20A	20A	20Ax2	20Ax2
Inlet Connection Size	3/4"	3/4"	1"	1"
Drain Connection Size	1 1/4"	1 1/4"	1 1/4"	1 1/4"
City Water Connection Size	3/8"	3/8"	3/8"	3/8"
Air Exhaust Connection Size	2 3/8"	2 3/8"	2 3/8"	2 3/8"
Inlet Water Pressure (PSI)	10Psi / 0.7bar	10Psi / 0.7bar	10Psi / 0.7bar	10Psi / 0.7bar
Ambient Temperature	2 C- 40	2 C- 40	2 C- 40	2 C- 40
Product Size (LxWxH) Inches	16.5x14x18	16.5x14x18	28x17x18	28x17x18
Product Weight (LBS)	62lbs	66lbs	176lbs	198lbs

Description	Model	Suggested Retail Price
-------------	-------	------------------------

Superb Vac 2 HP	(2x1HP) WV6(Twin)	
Superb Vac 2 HP	(2x1HP) (with recycler) WV6R(Twin)	
Superb Vac 4HP	(2x2HP) WV10(Twin)	
Superb Vac 4HP	(2x2HP) (with recycler) WV10R(Twin)	

Product includes the following:

6 Simultaneous users	✓	✓	✓	✓
10 Simultaneous users			✓	✓
Water recycler		✓		✓
220V 50/60Hz	✓	✓	✓	✓
Adjustable vacuum level from 8-15Hg	✓	✓	✓	✓
Low voltage control panel connections	✓	✓	✓	✓
Air Water Separator	✓	✓	✓	✓

Options	Model	Suggested Retail Price
---------	-------	------------------------

#WV-AWS	Single Pump Air/Water Separator	
#CP-2AV	Control Panel – 2 Button- 1 Vac / 1 Air	
#CP-3	Control Panel – 3 Button- 1 Vac / 1Air / 1 Water	
#CP-3AV	Control Panel – 3 Button- 2 Vac / 1 Air	
#CP-4	Control Panel – 4 Button- 2 Vac / 1 Air / 1 Water	
#CV22	Air Compressor and Vacuum Pump Stacking Rack	

OMC 2375CV-SL

Orthodontic Mobile Delivery Cabinet



Optional OMC 2200
Monitor Bracket



OMC2375CVSL



Artic

OMC-ST81



White

OMC-ST82



Cream

OMC-ST85



Bamboo

OMC-ST86

Optional hard surface stone top



Rear compartment
4" W X 12"D X 20" H

Writing surface with
optional solid surface

Function:

This self-contained orthodontic mobile delivery cabinet offers a pullout breadboard, two instrument drawers, one medium and two large storage drawers for materials and supplies that fully extend and quickly remove for easy cleaning. In addition, this cabinets provides a large open space for accessories with convenient access from the front. The oversized dual-caster wheels, makes positioning of the cabinet simple and easy on all floor surfaces, including carpet.

Standard Cabinet Features:

- Five easy to remove and clean full extension drawers, and one pull-out writing surface.
- High quality hardware throughout
- Oversized caster wheels with LOCKS
- Four stationary handles for easy cart positioning
- A removable counter - top plastic tray

Standard Control Features:

- 3 HP Automatic selection
- 3-way syringe
- Vacuum Package with Saliva Ejector and HVE
- Self contained water bottle system
- Variable speed disc-type foot control
- Water coolant on/off switch with flow control
- 1 Year warranty
- **Self contained dual compressor**

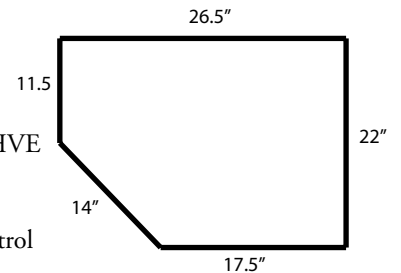

Description

Orthodontic Mobile Delivery Cabinet (Self contained)
Orthodontic Mobile Delivery Cabinet (Self contained)

Model

OMC2375CV-SL
OMC2375CV(No Scaler or LED curing light)

Suggested Retail Price

Options:

OMC2200	LCD Monitor Bracket W/ Post
OMC-ST81	Optional Stone Surface on OMC 2375, Color Artic
OMC-ST82	Optional Stone Surface on OMC 2375, Color White
OMC-ST85	Optional Stone Surface on OMC 2375, Color Cream
OMC-ST86	Optional Stone Surface on OMC 2375, Color Bamboo

Packing Dimensions: 32" x 28" x 41" / 180 lbs CV-SL model

PC 2700

Portable Dental Chair Package



Description

Portable Dental Chair Package

(Includes Patient Chair, Light, Stool, Tray, Spittoon & heavy duty Carry bags)

1 Year Warranty

Model

PC 2700

Suggested Retail Price

Options Model

Options	Model
PC 2720	Portable Patient Chair with Carrying Bag
PC 2740	Portable Dr. Stool with Carrying Bag
PC 2760	Portable Operator Light chair mounted
PC 2780	Stainless Steel tray and spit cup
PC 2790	Portable chair heavy duty carry bag
PC 2795	Stool heavy duty carry bag
PC2750	Portable LED Operator Light with Tripod Base with Carrying Bag

Shipping Dimensions: PC 2700

Packing Dimensions: 49" x 12" x 24" / 73 lbs

PC 2740

Packing Dimensions: 49" x 12" x 24" / 17 lbs

PC 2750

Packing Dimensions: 49" x 12" x 24" / 10 lbs.

PC 2630

Portable Delivery System

- PC2930: Includes
- LED Curing light
 - Piezo Scaler



PC2630



PC2930



The **PC2630** is a fully self contained air dental system. Quick and easy to setup and operate. Ready for travel. Tornado HP available upon request. Ask for details.

Description	Model	Suggested Retail Price
-------------	-------	------------------------

Portable Dental System	PC2630	
Portable Dental System W/ Scaler & LED Curing Light		PC2930

Package Includes the following

• 4 hole or 2 hole instrument tubings (specify)	✓	✓
• 3 way syringe	✓	✓
• Saliva ejector	✓	✓
• Self contained water bottle system	✓	✓
• Self contained oil less compressor (580W / 7L)	✓	✓
• Foot control	✓	✓
• Air venturi vacuum system	✓	✓
• Transportation case with pull out handle.	✓	✓
• 1 year warranty	✓	✓
• Built In Scaler		✓
• Built In Curing Light		✓

Options:

A800N-1	Advance 800 piezo scaler – built in	
INSTALL-1	LABOR (To Install Build-In Piezo Scaler with Additional Holder on PC2630)	
53012-INSTL	Female Quick disconnect (factory installed)	

Shipping Dimensions: pc2630

Packing Dimensions: 16" x 20" x 28" / 60 lbs

Shipping Dimensions: pc2930

Packing Dimensions: 16" x 20" x 28" / 65 lbs

Retail

PC 2635

Portable Delivery System



PC2635

The **PC2635** is a portable, self contained delivery system suitable for use in-office, nursing homes, hospitals, or wherever any off-site dentistry is required. The PC2635 is a lightweight, portable system that is easily transported. Air and water supply are included on the PC2635 portable dental system. Optional Tornado High and Slow speed handpieces are available.

Description

Model

Suggested Retail Price

Portable Dental System

PC2635

Package Includes the following

- 4 hole or 2 hole instrument tubings (specify)
- 3 way syringe
- Self contained oil less compressor (580W / 7L)
- Foot control
- Automatic handpiece flush System
- Built in carrying handle
- Self contained water bottle system
- 1 year warranty



Shipping Dimensions:

Packing Dimensions: 23" x 17" x 22" / 75 lbs

PC 2530

Mobile Vacuum System



PC2530

- Moves with Ease
- Efficient
- Simple Maintenance
- Perfect Backup
- Cost Effective
- Compact

Specifications

Electrical:	7/8 Horsepower 115 VAC, 50/60 Hz 230 VAC, 50/60 Hz 4.0 Amps
Sound:	70 db
Motor:	Variable speed control
Construction:	Metal Case
Vacuum:	80" of water (6" of Hg)
Airflow:	75 cfm
Canister:	2 Liter
Dimensions:	14" L x 12" W x 31" H
Shipping:	Freight

The PC 2530 Mobile Vac System is a portable, self contained vacuum system suitable for use by the dentist in a temporary location or when it is not feasible to install a central vacuum system.

Description	Model	Suggested Retail Price
Mobile Vacuum System	PC2530	

Package Includes the following

- 2 HVE and 1 SE Valves
- Drain Line
- 2 SE suction tips
- Power cord
- Solids trap
- 1 year warranty



Shipping Dimensions:

Packing Dimensions: 17" x 25" x 37" / 95 lbs



MC3600CV(SL)

Mirage Mobile Delivery Cart

- Moves with ease
- Efficient
- Simple maintenance
- No plumbing required
- Cost effective
- Compact



Clean Water Bottle



Waste Bottle



MC3600CVSL



Optional:

- #OMC2200 Monitor Bracket
- #MO17 LCD Monitor
- #UC100 Utility Tray
- #AIC5888 Intraoral camera

Specifications

Electrical: (2) X 550W head (115)VAC, 50/60 Hz 6.0 Amps
Sound: 68 db
Motor: Oil less air compressor
Construction: Metal Case
Vacuum: 80" of water (6" of Hg)

Vacuum: 80" of water (6" of Hg)
Max psi: 115 PSI / 40L per min
Waste Canister: 750ml
Shipping: Freight only

Physical Dimensions

31"H x 20"W x 16.5"D
Weight: 96 lbs

The MC3600CV (SL) is a self contained mobile delivery cart suitable for use by the dentist in a location when it is not feasible to connect to central plumbing

Description	Model	Suggested Retail Price
-------------	-------	------------------------

Mirage Mobile Delivery Cart	MC3600CV	
Mirage Mobile Delivery Cart		MC3600CV-SL
Package Includes the following		
• 3 way syringe, saliva ejector, hve	✓	✓
• 2 handpiece positions	✓	✓
• Variable speed disc-type foot control	✓	✓
• Self contained (dual compressor)	✓	✓
• Clean water Bottle	✓	✓
• Waste water Bottle	✓	✓
• Advance 800 Built in Piezo Scaler		✓
• LED 39 Built in Curing Light		✓
• Dual 110v outlet (rear of cart)	✓	✓
• 1 year warranty	✓	✓

Shipping Dimensions: Packing Dimensions: 39" x 27" x 23" / 160 lbs

ProClean

Extra Oral Suction System



Benefits:

- Captures and destroys viruses, germs and microorganism aerosols and droplets generated from high speed drilling and ultrasonic scaling at chairside
- Captures mercury vapors from amalgam removal
- Captures BPA particulates from composite material
- Neutralizes noxious chemical disinfectants odors and VOC gases
- Neutralizes smoke plum during dental laser and electrosurgery procedures
- Captures air abrasion and micro-etching dust

Filtration Process:

- Moisture Absorption Filter: Absorption of medium sized water droplets, moisture, aerosols and oils
- 2 Layer HEPA Filter: H13 Fine particle filter. Filtration of fine and ultra-fine dust, bacteria, viruses, fungi and prions. Efficiency: >99.97% @ >0.3 microns
- UV-C Germicidal Lamp: Disinfection and sanitation of air beyond filtration. Power: 10 watts, Wavelength: 254.7 nm
- Cold Plasma Ionizer: Eliminates particles as small as 0.01 microns including viruses, odor molecules and cigarette smoke

Technical Specifications:

Power Requirements:	100-120V AC, 50/60 Hz (International: 220-240V AC, 50/50 Hz)
Power	1200 Watts
Suction Pressure:	29 Kpa
Suction Flow:	4,000L/min (5Kpa)
Noise Level:	<65dB
New Weight;	64 lbs
Air Intake:	Segmented rotary arm with removable hood- 71.5" length x 2.5" diameter
UC-C Lamp Sterilization:	254.7 nm, 10 Watt
Plasma Disinfection:	5,000V
HEPA Grade H13:	0.3 micron, > 99.97%

Features:

- Kills 99.97% of viruses, germs and microorganisms
- Adjustable suction power
- Segmented rotary arm with replaceable wide-mouth suction hood
- Medical grade filtration system
- 2-year warranty

Description	Model	Suggested Retail Price
-------------	-------	------------------------

ProClean Extra Oral Suction System	PC2800	
------------------------------------	--------	--

Package Includes the following

- | | |
|--------------------|---|
| • Power Cord | ✓ |
| • Operation Manual | ✓ |
| • 2 year warranty | ✓ |

Options:

#PC2800-SYNFLTR	Replacement washable synthetic filter
#PC2800-HEPA13SML	Replacement HEPA-13 Small Filter
#PC2800-UVLAMP	Replacement UV Lamp
#PC2800-PLSMAGEN	Replacement Plasma Generator
#PC2800-HEPA13LG	Replacement HEPA-13 Large filter
#PC2800-Motor	Replacement Suction Motor

Retail

Shipping Dimensions:

ProClean : 29" x 19" x 38" / 85 lbs

Mirage

Operatory Stools

Model SS-5105



Dimensions:

Vertical adjustment range: 0" – 3.5"
 Seat width: 16"
 Seat height ranges: 24.5" – 31.8"
 5-Leg base diameter: 24"
 Shipping dimensions: 22" x 21" x 15" / 23 lbs.

Model DR-1102



Dimensions:

Backrest vertical adjustment range: 0" – 3.25"
 Seat width: 18"
 Seat height ranges: 19.5" – 24.8"
 5-Leg base diameter: 24"
 Shipping dimensions: 23" x 23" x 17" / 33 lbs.

Model DR-7000



Dimensions:

Backrest vertical adjustment range: 0" – 3.25"
 Seat width: 18.3"
 Seat height ranges: 19.5" – 24.8"
 5-Leg base diameter: 24"
 Shipping dimensions: 22" x 23" x 17" / 33 lbs.

Description

Model

Suggested Retail Price

Mirage saddle stool	SS-5105		
Mirage doctor's stool		DR-1102	
Solace doctor's stool			DR-7000

Stool Package includes the following:

Five-leg, ultra stable base, 24" diameter	✓	✓	✓
Gas cylinder lift for seat height adjustment	✓	✓	✓
Adjustable for right or left hand use	✓	✓	✓
Large, firm cushion seat	✓	✓	✓
Adjustable full ring foot rest			
Dual wheel casters	✓	✓	✓
Adjustable anatomical body support bar			
Height adjustment	23" - 31"	19" - 23"	19" - 23"
16 Upholstery color choices	✓	✓	✓
Seat tilt	✓	✓	✓
Optional adjustable armrest		✓	✓
1 year warranty	✓	✓	✓

Options *Specify Color And Product Code*

DR1102-9	Replacement DR1102 Seat Cushion ONLY Duration Vinyl
DR1102-11	Replacement DR1102 Chair Back Cushion ONLY Duration Vinyl
DR1102-Vinyl-UC	Upcharge Non Standard Vinyl DR1102 Upholstery upcharge
DR-1102-ULTR-UC	Upcharge Ultra leather DR1102 Upholstery upcharge
DR-7000-Vinyl-UC	Upcharge Non Standard Vinyl DR7000 Upholstery upcharge
DR-7000-ULTR-UC	Upcharge Ultra leather DR-7000 Upholstery upcharge
SS-5105-Vinyl-UC	Upcharge Non Standard Vinyl SS5105 Upholstery upcharge
SS-5105-ULTR-UC	Upcharge Ultra leather SS5105 Upholstery upcharge

Mirage

Operatory Stool

Model AS-1101



Dimensions:

Backrest vertical adjustment range: 0" – 3.25"
 Seat width: 18.5"
 Seat height ranges: 23" –30"
 5-Leg base diameter: 24"
 Packing dimensions: 24" x 23" x 21" / 42 lbs.

Model HY-5107



Dimensions:

Backrest vertical adjustment range: 0" – 3.25"
 Seat width: 17"
 Seat height ranges: 20" –25"
 5-Leg base diameter: 24"
 Packing dimensions: 22" x 21" x 15" / 30 lbs.

Model DRSA-7100-DU100



Dimensions:

Backrest vertical adjustment range: 0" – 3.25"
 Seat width: 18"x15.7"
 Seat height ranges: 20" –25"
 5-Leg base diameter: 24"
 Packing dimensions: 24" x 23" x 22" / 45 lbs.
 Only Available in black DU-100

Description

Model

Suggested Retail Price

Mirage Assistants stool

AS-1101

Mirage Hygiene stool

HY-5107

Mirage Mica Surgeon Stool

DRSA-7100-DU100

Stool Package includes the following:

Five-leg, ultra stable base, 24" diameter	✓	✓	✓
Gas cylinder lift for seat height adjustment	✓	✓	✓
Large, firm cushion seat	✓	✓	✓
Durable tile / carpet Casters	✓	✓	✓
Adjustable full ring foot rest	✓		
Adjustable for right or left handed use	✓		
Adjustable anatomical body support bar	✓		
Seat tilt		✓	✓
Height adjustment	22" - 29"	19" - 23"	19"-25
Adjustable armrest			✓
Available in 4 colors (DU-18, DU-100, DU-116, DU-220)		✓	DU-100 Black only
1 year warranty	✓	✓	✓

Options *Specify Color And Product Code*

AS1101-16	Replacement AS1101 Seat Cushion ONLY Duration Vinyl
AS1101-21	Replacement AS1101 Chair Back Cushion ONLY Duration Vinyl
AS1101-18	Replacement AS1101 Abdominal Bar Cushion ONLY Duration Vinyl
AS1101-Vinyl-UC	Upcharge Non Standard Vinyl AS1101 Upholstery Upcharge
AS1101-ULTR-UC	Upcharge Ultra leather AS1101 Upholstery Upcharge

Laguna

Operatory Stool

Model DR-5045



Dimensions:
 Backrest vertical adjustment range: 0" – 3.25"
 Seat width: 18" x 15.7"
 Seat height ranges: 20" – 25"
 5-Leg base diameter: 24"
 Packing dimensions: 24" x 23" x 20" / 33 lbs.

Model AS-5047



Dimensions:
 Backrest vertical adjustment range: 0" – 3.25"
 Seat width: 18.5"
 Seat height ranges: 23" – 30"
 5-Leg base diameter: 24"
 Packing dimensions: 24" x 23" x 20" / 42 lbs.

Description

Model

Suggested Retail Price

Laguna Assistants stool

AS-5047

Laguna Hygiene stool

DR-5045

Upholstery Selections:



Stool Package includes the following:

Five-leg, ultra stable base, 24" diameter	✓	✓
Gas cylinder lift for seat height adjustment	✓	✓
Large, firm cushion seat	✓	✓
Durable tile / carpet Casters	✓	✓
Adjustable full ring foot rest	✓	
Adjustable for right or left handed use	✓	
Adjustable anatomical body support bar	✓	
Seat tilt		✓
Height adjustment	22" - 29"	19" - 23"
Adjustable armrest		
1 year warranty	✓	✓

Options *Specify Color And Product Code*

Mirage

X-ray Chair



Model XR-6101

Dimensions:

Seat width: 21"
 Seat height ranges: 21.5" – 27.5"
 Base diameter: 24"
 Packing dimensions: 31" x 20" x 11" / 45 lbs.
 8" x 8" x 18" / 15 lbs.
 24" x 24" x 4" / 28 lbs.

Description	Model	Suggested Retail Price
-------------	-------	------------------------

Mirage Xray chair	XR-6101	
-------------------	---------	--

X-ray stool Package includes the following:

Adjustable headrest	✓	
Gas cylinder lift for seat height adjustment	✓	
Pneumatic pump on base	✓	
Large, firm cushion seat	✓	
Large diameter base	✓	
Height adjustment	✓	21.5" - 27.5"
16 Upholstery color choices	✓	
Arm rest	✓	
Leg rest	✓	
1 year warranty	✓	

Options

XR-6101-8-C	Replacement XR6101 Duration Vinyl Seat Cushion ONLY
XR-6101-9-C	Replacement XR6101 Duration Vinyl Chair Back Cushion ONLY
XR-6101-10-C	Replacement XR6101 Duration Vinyl Headrest Cushion ONLY
XR-6101-Vinyl-UC	Upcharge Non Standard Vinyl XR6101 Upholstery Upcharge
XR-6101-ULTR-UC	Upcharge Ultra leather XR6101 Upholstery Upcharge



Lustrous LED

Operatory Light



Model #L550-LED

Model L570-LED
Ceiling mounted

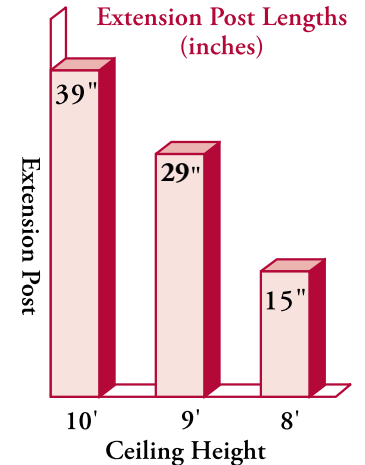

Packing Dimensions (L x W x H)	Weight
L900-08: 15 x 3 x 3	3 lbs.
L900-09: 30 x 3 x 3	5 lbs.
L900-10: 44 x 4 x 4	7 lbs.

#LP48 Light Post must be ordered if dental light is ordered separately

Specifications:

Dimmer mode:	From 8,000-30,000 Lux	Light intensity (Lux):	8,000 - 30,000 Lux @ 700mm 5,000 Kelvin
Input voltage:	110V/220V, 60/50 Hz	Cooling System:	Static Heat sink (no fan)
Output voltage:	24 Volts AC / DC	Illumination area:	100mm x 180mm @ 700mm

Description

Lustrous LED Post Mount Operatory Light

Lustrous LED Ceiling Mounted Light (specify 8', 9' or 10' ceiling)

Package includes the following:

Input voltage 24 Vac 50/60Hz

2 year warranty

Manual toggle / Motion sensor standard

PoliBlock Filter mode

Model

L550-LED

Suggested Retail Price

L570-LED

Input voltage 24 Vac 50/60Hz	✓	✓
2 year warranty	✓	✓
Manual toggle / Motion sensor standard	✓	✓
PoliBlock Filter mode	✓	✓

Options:

RLL-PS	110 - 240 V Power supply in 24 V out
LP-48	48" light post
L690-08	Ceiling post for 8' ceiling height
L690-09	Ceiling post for 9' ceiling height
L690-010	Ceiling post for 10' ceiling height
L690-011	Ceiling post for 11' ceiling height (special order)

Retail

Packing Dimensions (L x W x H)	Weight
L550: 17 x 15 x 7	7 lbs.
L570: 17 x 15 x 7	7 lbs.
L600 Arm: 34 x 11 x 5	10 lbs.
L690 Arm: 32 x 18 x 6	18 lbs.



Vivid LED

Operatory Light



Model #L700-LED

Model L795-LED
Ceiling mounted

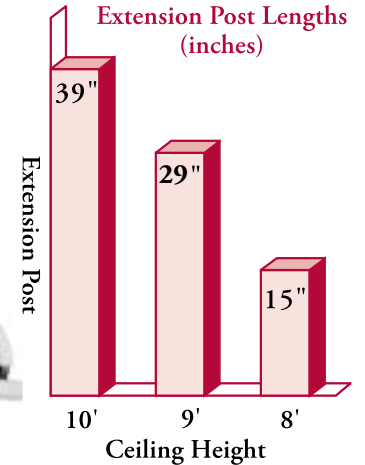

Packing Dimensions (L x W x H)	Weight
L900-08: 15 x 3 x 3	3 lbs.
L900-09: 30 x 3 x 3	5 lbs.
L900-10: 44 x 4 x 4	7 lbs.

#LP48 Light Post must be ordered if dental light is ordered separately

Specifications:

Dimmer mode:	From 3,000-35,000 Lux	Light intensity (Lux):	3,000 - 35,000 Lux @ 700mm
Input voltage:	110V/220V, 60/50 Hz	Cooling System:	Static Heat sink (no fan)
Output voltage:	24 Volts AC / DC	Illumination area:	100mm x 180mm @ 700mm

Description

Vivid LED Post Mount Operatory Light With Motion Sensor + Toggle

Model

L700-LED

Suggested Retail Price

Vivid LED Ceiling Mounted Light With Motion Sensor + Toggle
(specify 8', 9' or 10' ceiling)

L795-LED

Package includes the following:

Input voltage 24 Vac 50/60Hz	✓	✓
2 year warranty	✓	✓
Manual toggle / Motion sensor standard	✓	✓
PoliBlock Filter mode	✓	✓

Options:

RLL-PS	110 - 240 V Power supply in 24 V out
LP-48	48" light post
L690-08	Ceiling post for 8' ceiling height
L690-09	Ceiling post for 9' ceiling height
L690-010	Ceiling post for 10' ceiling height

Retail

Packing Dimensions (L x W x H)	Weight
L700-LED: 38 x 17 x 15	10 lbs.
L795-LED: 38 x 17 x 15	18 lbs.

Packing Dimensions (L x W x H)	Weight
Light Head: 14 x 9 x 14	7 lbs.



Lucent LED

Operatory Light



Model #L600-LED



Model L690-LED
Ceiling mounted
Lucent LED
operatory light.

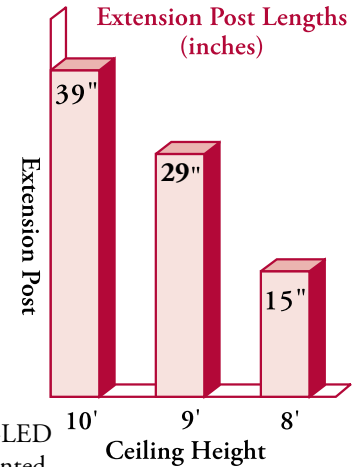

Packing Dimensions (L x W x H)	Weight
L900-08: 15 x 3 x 3	3 lbs.
L900-09: 30 x 3 x 3	5 lbs.
L900-10: 44 x 4 x 4	7 lbs.

#LP48 Light Post must be ordered if dental light is ordered separately
Specifications:

Absorbed Power:	Max 8vA
Input voltage:	110V/220V, 60/50 Hz
Output voltage:	24 Volts AC / DC

Light intensity (Lux):	3,000 - 35,000 Lux @ 700mm
Cooling System:	Static Heat sink (no fan)
Illumination area:	100mm x 180mm @ 700mm

Description	Model	Suggested Retail Price
-------------	-------	------------------------

Lucent LED Post Mount Operatory Light	L600-LED	
Lucent LED Post Mount Operatory Light with motion sensor	L625-LED	
Lucent LED Ceiling Mounted Light (specify 8', 9' or 10' ceiling)		L690-LED
Lucent LED Ceiling Mounted Light (specify 8', 9' or 10' ceiling) with motion sensor		L695-LED

Package includes the following:

Input voltage 110V	✓	✓	✓	✓
2 year warranty	✓	✓	✓	✓
Dimmer Mode	✓	✓	✓	✓

Options:

RLL-H04	Replacement LED light optical bulb group
RLL-H06	Replacement light handle (Left and Right)
RLL-H01	Replacement shield
RLL-H03	Replacement reflector / set of 2
RLL-PS	110 - 240V Power supply in 24V out
LP-48	48" light post
L690-08	Ceiling post for 8' ceiling height
L690-09	Ceiling post for 9' ceiling height
L690-010	Ceiling post for 10' ceiling height
L690-011	Ceiling post for 11' ceiling height (special order)

Retail

Packing Dimensions (L x W x H)	Weight
L600: 34 x 11 x 5	10 lbs.
L690: 32 x 18 x 6	18 lbs.

Packing Dimensions (L x W x H)	Weight
Light Head: 14 x 9 x 14	7 lbs.



Radiant LED

Operatory Light



Radiant light handles are removable and sterilizable

R6101-LED

#LP48-RI Light Post must be ordered if dental light is ordered separately
Specifications:

Absorbed Power:	Max 8vA	Light intensity (Lux):	3,000 - 35,000 Lux @ 700mm
Input voltage:	110V/220V, 60/50 Hz	Cooling System:	Static Heat sink (no fan)
Output voltage:	24 Volts AC / DC	Illumination area:	100mm x 180mm @ 700mm
Bulb type:	LED		

Description	Model	Suggested Retail Price
Radiant LED Operatory Light	R6101-LED	
Radiant LED Operatory Light with motion sensor		R6105-LED

Package includes the following:

Input voltage 110V - 240 Vac	✓	✓
2 year warranty	✓	✓
Dimmer Mode	✓	✓

Options: **Retail**

RLL-H04	Replacement LED light optical bulb group
RLL-H06	Replacement light handle (Left and Right)
RLL-H01	Replacement shield
RLL-H03	Replacement reflector / set of 2
RLL-PS	110 - 240 V Power supply in 24 V out
LP-48-RI	48" light post
408500	Wall Mount Bracket

Packing Dimensions (L x W x H)	Weight
Arm: 17 x 6 x 36	14 lbs.
Head: 14 x 14 x 9	8 lbs.

Nylon Bushing

#LP-RI-S Included with models
 R6101-LED, R6105-LED

- OD 1 7/8"
- ID 1 3/8"





Luminous LED

LED Operatory Light

with PoliBlock Filter



Luminous light handles are removable and sterilizable

#L7601-LED

#LP48-RI Light Post must be ordered if dental light is ordered separately
Specifications:

Absorbed Power:	Max 8vA	Light intensity (Lux):	3,000 - 35,000 Lux @ 700mm
Input voltage:	110V/220V, 60/50 Hz	Cooling System:	Static Heat sink (no fan)
Output voltage:	24 Volts AC / DC	Illumination area:	100mm x 180mm @ 700mm
Bulb type:	LED		

Description	Model	Suggested Retail Price
Luminous LED Operatory Light	L-7601-LED	
Luminous LED Operatory Light with motion sensor	L-7605-LED	
Luminous LED Operatory Light Ceiling Mount	L-7901-LED	

Package includes the following:

Input voltage 110V - 240 Vac	✓
2 year warranty	✓

Options:

LU-PB	Antipolymerization Filter "Poli-Block"	Retail
408500	Wall Mount Bracket	

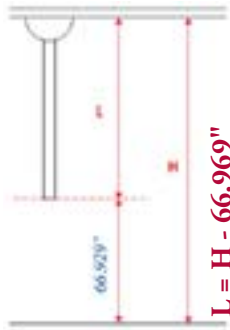

*** Ceiling light extension post must be cut at the time of installation.**

Nylon Bushing

#LP-RI-S	Included with models
• OD 1 7/8"	R6101-LED, R6105-LED
• ID 1 3/8"	

Packing Dimensions (L x W x H)	Weight
Light Arm: 17" x 6" x 36"	18 lbs.
Light Head: 14 x 14 x 9	

PC2730

Portable LED Operatory Light

W/ Tripod Base



Specifications:

Absorbed Power: 10 Watts

Max

Input voltage: 110V/220V, 60/50 Hz

Output voltage: 12 Volts DC

Bulb type: LED

Light intensity (Lux): 16,145 Lux @ 61cm

Cooling System: Static Heat sink (no fan)

Color Temperature: 6,500 K

Lamp Height: 41" - 69"

Boom Length: 41"

Duty cycle: Continuous

LED life: 10,000 hours min

Intensity adjustment: 0 - 100%

Normal working distance: 16" - 36"



Description

Portable LED operatory light with tripod base

Model

PC2750

Suggested Retail Price

Package includes the following:

Input voltage 110V - 240 Vac Power supply

✓

Carry bag

✓

Options:

PC-2760-PS Replacement power supply for portable LED operatory light

PC-2798 Carry bag for portable LED operatory light

Retail

Packing Dimensions (L x W x H)	Weight
Light: 8" x 8" x 32"	10 lbs.

Mobile Cabinet Systems



Utility Mobile Cabinet
#TMC-180

- 14.5" W x 16" D x 32" H
- designed for ultrasonic scalers, curing lights, electrosurge, intraoral cameras, etc.
- 1 instrument drawer
- 2 adjustable shelves
- 1 year warranty
- Shipping dimensions: 20" x 22" x 34" / 65 lbs.



Doctor's Mobile Cabinet
#TMC-140

- 21.5" W x 19" D x 32" H
- 4 instrument drawers
- 3 storage drawers
- 1 year warranty
- Shipping dimensions: 33" x 22" x 24" / 110 lbs.



Assistant's "Alabama" Mobile Cabinet
#TMC-160

- 21.5" W x 19" D x 32" H
- Sliding counter top with amalgamator well
- 1 instrument drawer
- 2 storage drawers
- Side to side sliding counter
- 1 year warranty
- Shipping dimensions: 33" x 22" x 24" / 110 lbs.



Assistant's "North Carolina" Mobile Cabinet
#TMC-120

- 21.5" W x 19" D x 32" H
- Solid top with pull handle
- Amalgamator well drop leaf door
- 3 instrument drawers
- 1 storage drawer
- 1 year warranty
- Shipping dimensions: 33" x 22" x 24" / 110 lbs.



- White will be shipped if color choice not indicated on purchase order
- Mobile cabinets ship on pallet via freight carrier

Description	Model (light grey)	Model (white)	Suggested Retail Price
Utility Mobile Cabinet	TMC-180-G	TMC-180-W	
Doctor's Mobile Cabinet	TMC-140-G	TMC-140-W	
Assistant's "Alabama" Mobile Cabinet	TMC-160-G	TMC-160-W	
Assistant's "North Carolina" Mobile Cabinet	TMC-120-G	TMC-120-W	
Assistant's "North Carolina" Mobile Cabinet RT pull out		TMC-120R-W	

Package includes the following:

External surfaces of high pressure laminate with complimentary white interior surface for easy cleaning. Smooth flowing ball bearing glides. Durable casters. Color choice: white or light grey. 1 year warranty



17" LCD Monitor

Multimedia Monitor



#M017



Intraoral Camera Port



Multimedia Input port

- Multimedia Monitor
- Glass panel
- 4:3 Screen
- DVD, Intraoral Camera READY!!
- Full 17" viewable TFT Active Matrix flat panel display
- Auto adjustment function
- Built-in dual speakers
- On screen display controls (OSDC)
- Recommended resolution: 1280 x 1024 (17")
- Universal 100-240 VAC, 50/60 Hz
- Gross weight: 11.6 lbs
- Includes: AC adapter, remote control, monitor handle, camera holder
- Connections: Video-in, HDMI, RGA-in, audio-in, DC-in, Flash Drive Media Player
- 1 year warranty

Description

Model

Suggested Retail Price

17" LCD multi media monitor

MO17

Shipping Dimensions 17" Monitor: 18" x 6" x 21" / 12 lbs.
(2/cs.) 19" x 12" x 22" / 27 lbs.

LCD Monitor Brackets

Monitor Brackets



WIC800

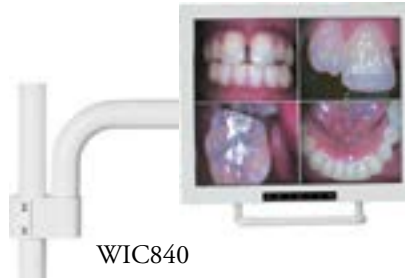

WIC840



WIC840

Standard LCD Monitor Bracket

- Easily position the angle of your monitor for maximum comfort and productivity
- 4-way pivot adjustment
- Standard 75mm spacing
- 1 Year warranty

Packing Dimensions:
11" x 7" x 6" 6 lbs.
(4/cs.) 15" x 12" x 11" 25 lbs.

Mirage Monitor Bracket

- 16" extension arm
- Horizontal travel
- 4-way pivot adjustment
- Standard 75mm spacing
- 1 Year warranty

Packing Dimensions:
15" x 10" x 5" 9 lbs.

Expansion Plate for 100mm Spacing

- 1 year warranty



M100mm

WIC875



Monitor Adapter for AdvanceCAM Intraoral Camera & Docking Station

WIC865



Standard and Deluxe LCD Monitor Bracket

May be wall mounted

- 1 year warranty

Description

Model

Suggested Retail Price

Description	Model	Suggested Retail Price
Standard LCD Monitor Bracket	WIC800	
Mirage LCD Monitor Bracket with 16" Extension Arm	WIC840	
Expansion Plate for 100 mm spacing pattern	M100mm	
Wall Plate Adapter	WIC865	
Monitor Adapter for AdvanceCAM Intraoral Camera & Docking Station	WIC875	

Super Thin

LED X-Ray Viewer



- Viewing Area: 8.5" H x 11" W x 0.5" Thick
- Countertop, wall, or unit head mounted
- AC power source
- Sealed LED lights
- Instant illumination
- No grey in viewing area
- Viewing area accepts panoramic, cephalometric and regular size film
- 0.5" super thin viewer
- 1 year warranty



XV150-R
*Mount to TPC
Mirage Unit (Round Arm)

XV150-F
*Mount to Flat Arm

Description

Model

Suggested Retail Price

Super Thin X-ray Viewer

XV100

Package Dimensions: 17" x 11" x 2" / 3 lbs.
(10/cs.) 17" x 11" x 19" / 28 lbs.

Options:

Retail

XV150-R Xray viewer bracket (round cut-out) – mount to Mirage unit head (Round Arm)
 XV150-F Xray viewer bracket (flat cut-out) – mount to unit head (Flat Arm)
 XV130 Replacement LED light strip
 XV100-PSW Viewer replacement power supply
 XV100-CLIP Viewer replacement Clip (3 Pack)

AIC5899



Specifications

- Imager Sony 1/4" CCD
- Capture Size 640 X 480
- Light Source 6 White LEDs
- Power USB 5VDC
- Frame Rate 30 fps MAX
- PC connection USB 2.0 Port

System Requirements

- Intel Pentium 4 .15 GHZ or Higher
- 512 MB RAM or higher
- Windows XP or higher
- USB 2.0 port



Description

Corded Direct USB Camera System

Model

AIC5899

Suggested Retail Price

Options:

- AIC500 Advance Cam Barriers, 500 / Box
- AIC930 Advance Cam Camera Holder
- AIC928-USB Advance Cam USB Camera Cable

Retail

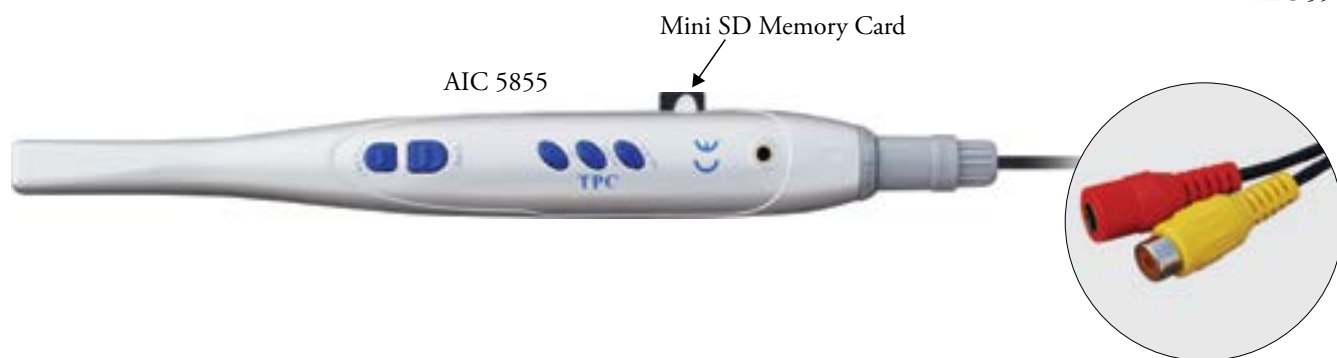

Specifications

- imager Sony 1/4" CCD
- capture Size 640 X 480
- light Source 6 White LEDs
- power 5VDC
- supported Mini SD Up to 16GB



Optional
AIC500

Description

Mini SD Card Camera System
(Both Corded and Cordless)

Model

AIC 5855-PKG
(Includes: AIC5855+5901+5111)

Suggested Retail Price

Options:

- AIC5855 Advance Cam Intraoral Camera (Corded Only) with Mini SD Card
- AIC5901 Mini SD Cam Power Supply
- AIC500 Advance Cam Barriers, 500 / Box
- AIC5111 Camera Mounted LCD Display 2.5"

Retail



Specifications

- Imager Sony 1/4" CCD
- Capture Size 640 X 480
- Light Source 6 White LEDs
- Power USB 5VDC
- Frame Rate 30 fps MAX
- Connections AV & Composite VGA, HDMI
- Frequency 2.4 Ghz
- Memory Micro SD 4 gb

System Requirements

- Intel Pentium 4 .15 GHZ or Higher
- 512 MB RAM or higher
- Windows XP or higher
- Optional: USB 2.0 port



Description

Corded Camera & Docking Station System

Model

AIC5888-5925W-KT (includes AIC5888+AIC5925)

Suggested Retail Price

Options:

- AIC5888 Advance Cam Intraoral Camera
- AIC5925 Advance Cam Docking Station
- AIC930 Advance Cam Camera holder
- AIC5111 Camera Mounted LCD Display 2.5"
- AIC500 Advance Cam Barriers, 500 / Box
- AIC966 Wifi adaptor

Retail



AIC5925W

AIC5900



AIC5888



AIC5920

System Requirements

Intel Pentium 4 .15 GHZ or Higher

512 MB RAM or higher

Windows XP or higher

USB 2.0 port



Optional:
AIC5111



Specifications

- Imager Sony 1/4" CCD
- Capture Size 640 X 480
- Light Source 6 White LEDs
- Power USB 5VDC - 12VDC
- Frame Rate 30 fps MAX
- Connections USB, AV, Composite, VGA, HDMI
- Memory SD Memory Card 4 GB
- Frequency 5.8 Ghz



Description

Cordless Camera & Docking Station System

Model

WL-CAM+DS-PKG
(Includes: AIC5888+5925W+5900+5920)

Suggested Retail Price

Options:

- AIC5888 Advance Cam Intraoral Camera
- AIC5925 Advance Cam Docking Station
- AIC 5900 Wireless Transmitter
- AIC5111 Camera Mounted LCD Display 2.5"
- AIC500 Advance Cam Barriers, 500 / Box
- AIC5920 Wireless Receiver
- AIC966 Wifi Adaptor

Retail

17" LCD Monitor

Multimedia Monitor / Camera Combo



Features:

- Camera features a 1/4" High Definition image sensor
- 17" Monitor features a High Definition resolution of 1280 X 1024
- Full USB port allows for easy image transfer
- Camera buttons are easily accessible to control capture and playback functions
- Camera is illuminated with six bright LEDs; giving the best contrast, definition and resolution
- Camera features an automatic gain control to automatically adjust the light intensity to the CCD
- 5.8 GHz wireless transmission protocol
- Four channel wireless transmitter (AIC5900) and receiver (AIC5920)
- Input supports: USB, VGA, HDMI and AV.
- Medial playback format includes: MP3 audio, MP4 video and JPG images
- Adjustments on monitor include: Contrast, brightness and color
- Monitor comes equipped with a medical grade tempered glass front panel to minimize scratches
- Monitor Language supported: English, Chinese, Spanish, German, Portuguese and Arabic
- 4gb memory card (included) allows for easy image transfer and patient file management
- Optional WIFI transmitter allows images to be displayed on stand alone LCD monitor and remote computers simultaneously for easy consultation and image management transfer.
- Easy integration of LCD monitor with camera on the dental delivery unit due to no additional cabling needed

Description

Model

Suggested Retail Price

17" LCD monitor with integrated IO camera corded
Includes: MO17DS, AIC5888A

AIC3IN1W

17" LCD monitor with integrated IO camera wireless
Includes: MO17DS, AIC5888 A, AIC5920, AIC5900

AIC3IN1WL

Options:

Retail

AIC500 Advance Cam Barriers, 500 / Box

AIC966 Wifi Adapter

Shipping Dimensions 17" Monitor: 18" x 6" x 21" / 12 lbs.
(2/cs.) 19" x 12" x 22" / 27 lbs.

EMC - 900

eTornado Electric Motor System



eTornado Electric Motor Features:

- Fiber optic brushless electric motor
- Two programmable settings for each mode
- Push button control for easy operation
- Light weight, compact - ergonomic design
- Counter top system is easy to install and integrate
- Universal e-type connector compatible with most
- Speed range from 100 - 200,000 rpm

Specifications

- 2 General / Basic Endo Modes
- e-type attachment / coupling
- Manual reverse
- Unit dimensions
4.5"W X 5.25" D X 2.5"H
- Motor weight: 87 grams
- Motor Length: 50mm
- Input Voltage: 100 - 240 Vac
- Output Voltage: 30Vac

Easy to install and integrate with any dental unit.

<u>Description</u>	<u>Model</u>	<u>Suggested Retail Price</u>
--------------------	--------------	-------------------------------

e Tornado Electric Motor System - Counter top	EMC-900	
---	---------	--

Package includes the following:

e Tornado Electric Motor System - Counter top	✓
Power Pack	✓
HP Tubing	✓
E600 Electric Motor up to 40,000 rpm	✓

Options.

EMA150-FG	1:5 Friction Grip Attachment
EMA110-CA	1:1 Contra Angle Attachment
EMP30	Power Supply 30Vac, 4A for control box
EMC-600-T	Replacement HP tubing
EM-600	Replacement Motor

Shipping Dimensions: 11" x 11" x 5" / 5 lbs.

EMB - 901

eTornado Electric Motor System



Electric Motor With Tubing



eTornado Control Box



eTornado Touchpad

EMT-915

eTornado Electric Motor Features:

- Fiber optic brushless electric motor
- Two programmable settings for each mode
- Push button control for easy operation
- Light weight, compact - ergonomical design
- Built in system pre wired for easy installation
- Universal e-type connector compatible with most electric attachments
- Speed range from 100 - 200,000 rpm

Specifications

- 2 General / Basic Endo Modes
- e-type attachment / coupling
- Manual reverse
- Unit dimensions
4.5"W X 5.25" D X 2.5"H
- Motor weight: 87 grams
- Motor Length: 50mm
- Input Voltage: 100 - 240 Vac

Description

eTornado Built in Electric Motor System

Model

EMB-901

Suggested Retail Price

Package includes the following:

- eTornado Electric Motor System - Built in
- Power Pack
- HP Tubing
- E600 Electric Motor up to 40,000 rpm



Options

- EMA150-FG 1:5 Friction Grip Attachment
- EMA110-CA 1:1 Contra Angle Attachment
- EMB-901-PCB Replacement Main PCB Board
- EMB-600-T Replacement HP tubing
- EM-600 Replacement Motor

Shipping Dimensions:

EMA-150FG

High Speed Contra Angle Attachment



EMA-110 CA

EMA-150FG

Description	Model	Suggested Retail Price
1:5 Friction Grip Attachment	EMA-150FG	
1:1 Contra Angle Attachment	EMA-110CA	
Package includes the following:		
Push Button Auto Chuck	✓	
Quattro Water Spray	✓	
Speed Range up to 200,000 rpm	✓	
Attachment to electric motor w/ E-type connection	✓	
Max Lux of 32,000	✓	

Shipping Dimensions:

High Speed Handpieces Overview

All High Speed Handpieces Use Ceramic Bearings

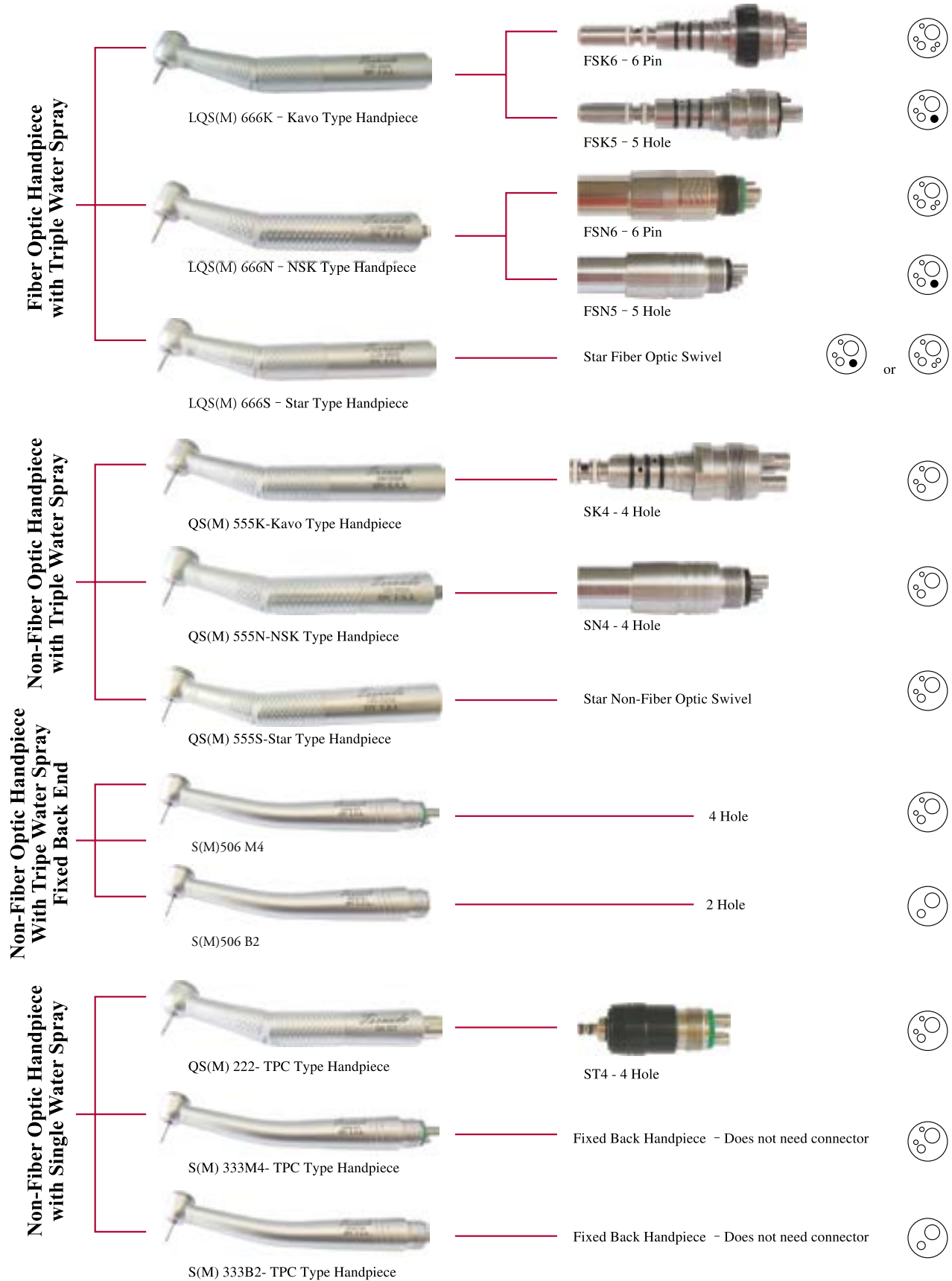

Fiber Optic Handpieces

Triple Water Spray / Push Button / Auto Chuck / Ceramic Bearing

Premius Series



Fiber Optic
w/Triple
Water Spray



LQS 666 (K,N,S)



Standard Head



LQM 666 (K,N,S)



Mini Head

FIBER OPTIC QUICK CONNECTORS

(Swivel)



FSK6 Kavo Type 6 Pin



FSK5 Kavo Type 5 Hole



FSN6 NSK Type 6 Pin

Description	Model	Suggested Retail Price
Kavo Type Fiber Optic HP <u>Standard</u> Head w/Triple Water Spray Fits Kavo Connector	LQS666K	
Kavo Type Fiber Optic HP <u>Mini</u> Head w/Triple Water Spray Fits Kavo Connector	LQM666K	
6 Hole (ISO-C) Fiber Optic Connector Fits Handpiece with KAVO "Multiflex" Quick Connector System	FSK6-LED	
5 Hole (Midwest) Fiber Optic Connector Fits Handpiece with KAVO "Multiflex" Quick Connector System	FSK5	
NSK Type Fiber Optic HP <u>Standard</u> Head w/Triple Water Spray Fits NSK Connector	LQS666N	
NSK Type Fiber Optic HP <u>Mini</u> Head w/Triple Water Spray Fits NSK Connector	LQM666N	
6 Hole (ISO-C) Fiber Optic Connector Fits Handpiece with NSK Quick Connector System	FSN6	
Star Type Fiber Optic HP <u>Standard</u> Head w/Triple Water Spray Fits Star Connector	LQS666S	
Star Type Fiber Optic HP <u>Mini</u> Head w/Triple Water Spray Fits Star Connector	LQM666S	

Non-Fiber Optic Handpieces

Triple Water Spray / Push Button / Auto Chuck / Ceramic Bearing

Optimus Series



Non-Fiber Optic
w/Triple
Water Spray



QS 555 (K,N,S)



Standard Head



QM 555 (K,N,S)



Mini Head

NON-FIBER OPTIC QUICK CONNECTORS

(Swivel)



SK4 Kavo Type 4 Hole



SN4 NSK Type 4 Hole

Description	Model	Suggested Retail Price
Kavo Type Non-Fiber Optic HP <u>Standard</u> Head w/Triple Water Spray Fits Kavo Connector	QS555K	
Kavo Type Non-Fiber Optic HP <u>Mini</u> Head w/Triple Water Spray Fits Kavo Connector	QM555K	
4 Hole Non-Fiber Optic Connector Fits Handpiece with KAVO "Multiflex" Quick Connector System	SK4	
NSK Type Non-Fiber Optic HP <u>Standard</u> Head w/Triple Water Spray Fits NSK Connector	QS555N	
NSK Type Non-Fiber Optic HP <u>Mini</u> Head w/Triple Water Spray Fits NSK Connector	QM555N	
4 Hole Non-Fiber Optic Connector Fits Handpiece with NSK Quick Connector System	SN4	
Star Type Non-Fiber Optic HP <u>Standard</u> Head w/Triple Water Spray Fits Star Connector	QS555S	
Star Type Non-Fiber Optic HP <u>Mini</u> Head w/Triple Water Spray Fits Star Connector	QM555S	

Non-Fiber Optic Handpieces (Standard Back End)

Triple Water Spray / Push Button / Auto Chuck / Ceramic Bearing

Triton Series



S504 M4 / S506 M4



Standard Head



M504 M4 / M506 M4



Mini Head

Non-Fiber Optic
w/Triple
Water Spray

Description	Model	Suggested Retail Price
Non-Fiber Optic HP <u>Standard</u> Head w/Triple Water Spray Standard Back End-4 Hole	S504M4 / S506M4	
Non-Fiber Optic HP <u>Mini</u> Head w/Triple Water Spray Standard Back End-4 Hole	M504M4 / M506M4	
Non-Fiber Optic HP <u>Standard</u> Head w/Triple Water Spray Standard Back End-2 Hole	S502B2	
Non-Fiber Optic HP <u>Mini</u> Head w/Triple Water Spray Standard Back End-2 Hole	M502B2	

Non-Fiber Optic Handpieces

Single Water Spray / Push Button / Auto Chuck / Ceramic Bearing

Nexius Series



Non-Fiber Optic
w/Single
Water Spray



QS 222 Standard Head



Standard Head



QM 222 Mini Head



Mini Head

NON-FIBER OPTIC QUICK CONNECTORS (Swivel)



ST4 TPC Type 4 Hole

Description	Model	Suggested Retail Price
Non-Fiber Optic HP (Standard Head) with Single Water Spray Fits TPC Connector	QS222	
Non-Fiber Optic HP (Mini Head) with Single Water Spray Fits TPC Connector	QM222	
4 Hole Non-Fiber Optic Connector Fits Handpiece with TPC Quick Connector System	ST4	

Non-Fiber Optic Handpieces (Standard Back End)

Single Water Spray / Push Button / Auto Chuck / Ceramic Bearing

Nexius Series



Non-Fiber Optic
w/Single
Water Spray



S333M4 Standard Head



Standard Head



M333M4 Mini Head



Mini Head



P333M4 Pedo Head



Pedo Head

Description	Model	Suggested Retail Price
Push Button Autochuck (Standard Head) with Single Water Spray Standard Back End -4 Hole	S333M4	
Push Button Autochuck (Mini Head) with Single Water Spray Standard Back End -4 Hole	M333M4	
Push Button Autochuck (Standard Head) with Single Water Spray Standard Back End -2 Hole	S333B2	
Push Button Autochuck (Mini Head) with Single Water Spray Standard Back End -2 Hole	M333B2	
Push Button Autochuck (Pedo Head) Standard Back End -4 Hole	P333M4	

Low Speed Handpieces

External Water Coolant

Internal Water Coolant

Exomus Series



ELM 744: Air Motor, Speed range up to 20,000 rpm, forward / reverse speed adjustment



ELS 736: Transmission 1:1, speed range up to 20,000 rpm



ELCA 760: Transmission 1:1, push button autochuck, for latch burs



ELCA 762: Transmission 1:1, latch type, for latch burs

Inximus Series



ILM 844: Air Motor, Speed range up to 20,000 rpm, forward / reverse speed adjustment, internal air/water coolant



ILS 836: Transmission 1:1, internal water spray



ILCA 860: Transmission 1:1, internal water spray, push button auto chuck for latch burs



Description

External Water Low Speed Complete package includes
 (Air motor, straight nose cone HP, Push button contra angle HP)
 External Water Low Speed Complete package includes
 (Air motor, straight nose cone HP, Latch type contra angle HP)
 Low Speed Motor, External Water, 20,000 rpm (4 hole)
 Low Speed Motor, External Water, 20,000 rpm (2 hole)
 Straight nose cone HP, 1:1
 Push button contra angle HP, Complete 1:1
 Latch type contra angle HP, Complete 1:1
 Internal Water Low Speed Complete package includes
 (Air motor, straight nose cone HP, push button contra angle HP)
 Low Speed Motor (Internal Water) 20,000 rpm-4 hole
 Straight nose cone HP, 1:1
 Push Button Contra Angle HP, Complete 1:1

Model

ELK700-M4
 ELK702-M4
 ELM744-M4
 ELM722-B2
 ELS736
 ELCA-760
 ELCA-762
 ILK800-4
 ILM844-4
 ILS-836
 ILCA860

Suggested Retail Price

Prophy Aide

Hygiene Prophy Handpiece



Description

Model

Prophy Aide Hygiene Handpiece
Prophy Aide Hygiene Handpiece
Package includes the following:

PH-777 (Red)
PH-777 (BLK)

4 Hole fixed back end
5,000 RPM
Twist open chuck
360 Head Swivel Capabilities
Forward and Reverse operation



Fiber Optic Light Source

Light Source Package



H 7070
Fiber Optic Light Bulb
Cartridge



H 7040
Fiber Optic 5-Hole Tubing



H 7020
Control Board



H 7045
Fiber Optic 6-Pin Tubing



H 7090
Fiber Optic Transform



H 7660 - 6 Pin



H 7000 - 5 Hole

Package includes: H7020+H7045+H7090

Package includes: H7020+H7040+H7070+H7090

Description	Model	Suggested Retail Price
TPC Fiber Optic Light Source System- 6 Pin Package includes: Control board, Fiber Optic HP Tubing, Transformer	H7660	
TPC Fiber Optic Light Source System- 5 Hole Package includes: Control board, Fiber Optic HP Tubing, Transformer, Bulb Cartridge	H7000	
TPC Fiber Optic Control Board (accepts two Fiber Optic HP Tubing)	H7020	
TPC Fiber Optic HP Tubing-6 Pin, Grey	H7045	
TPC Fiber Optic HP Tubing- 5 Hole, Grey	H7040	
TPC Fiber Optic Light Bulb Cartridge LED	H7070-LED	
TPC Fiber Optic Light Source Transformer	H7090	

Power Optic Quick Connects

Handpiece Quick Connect Couplers



FSK6 Kavo Type 6 Pin

FSK5 Kavo Type 5 Hole

FSN6 NSK Type 6 pin

FSN5 NSK Coupler 5 Hole



TRP213
Halogen Bulb



H7070
Halogen Bulb



TRP215
Halogen Bulb



H7070
Halogen Bulb



TRP213-LED
LED Bulb for T-Series



TRP215-LED
LED Bulb for NSK

Description

Model

Suggested Retail Price

Kavo Type 5 Hole power optic connector	FSK5	
Kavo Type 6 Pin power optic connector	FSK6	
NSK Type 6 Pin power optic connector	FSN6	
NSK Type 5 Hole power optic connector	FSN5	
Halogen light bulb for FSK6 Kavo type t-Series	TRP-213	
LED light bulb (black casing) for FSK6 Kavo type t-series	TRP-213-LED	
Halogen light bulb for FSN6 NSK type	TRP-215	
LED light bulb for FSN6 NSK type	TRP-215-LED	
LED light bulb for FSK6 Kavo type	TRP-218	
LED light bulb black cartridge type	H7070-LED	

Replacement Turbines & Parts

Handpiece Replacement Parts

REPLACEMENT TURBINES

Item #	Description	Retail
TRT 110S	Replacement turbine fits Tornado HP LQS 666, QS 555, Standard Head	
TRT 115M	Replacement turbine fits Tornado HP LQM 666, QM 555, Mini Head	
TRT 120S	Replacement turbine fits Tornado HP S333, Standard Head	
TRT 122S	Replacement turbine fits Tornado HP QS222, Standard Head	
TRT 125M	Replacement turbine fits Tornado HP QM222, M333, Mini Head	
TRT 130	Push button turbine fits Kavo Super Torque 630 B/C and 640 B/C	
TRT 135	Push button turbine fit for Kavo Super Torque 647B and 649 B	
TRT 140	Push button turbine fit for Kavo Bella Torque 639B/C and 642 B/C	
TRT 145	Push button turbine fit for Kavo Mira 635 B	
TRT 150	Push button turbine fit for Star 430 Series Handpiece	
TRT 155	Turbine fit for Midwest Quiet Air L F.O & Non F.O. HP	
TRT 160	Turbine fit for Midwest Tradition L F.O & Non F.O. HP	
TRT 165	Turbine fit for Midwest Tradition F.O & Non F.O. HP	
TRT 170	Turbine fit for Midwest XGT/Tradition PB F.O & Non F.O. HP	

REPLACEMENT PARTS

Item #	Description	Retail
TRP 213	Replacement Light Bulb for FSK6 (Kavo Type Quick Connector)	
TRP 215	Replacement Light Bulb for FSN6 (NSK Type Quick Connector)	
TRP 220	Back Cap Removal Tool for LQS 666, QS 555	
TRP 222	Back Cap Removal Tool for LQM 666, QM 555	
TRP 224	Back Cap Removal Tool for QS 222	
TRP 226	Back Cap Removal Tool for QM 222, M 333	
TRP 228	Back Cap Removal Tool for S 333	
TRP 231	Replacement Push Button Cap for LQS 666, QS 555	
TRP 233	Replacement Push Button Cap for LQM 666, QM 555	
TRP 235	Replacement Push Button Cap for QS 222	
TRP 237	Replacement Push Button Cap for QM 222, M 333	
TRP 239	Replacement Push Button Cap for S 333	
TRP 240	Replacement O Ring for FSK6, FSK5, Sk4 (Pack of 5 (2 white, 3 black))	



TRP 215



TRP 240

H6000

Handpiece Lubrication System

Product Features

- Economical, efficient and time-saving
- A fail-safe maintenance solution for your office
- Filtered air used to rotate handpieces for safety
- Care for most handpieces and all handpieces brands
- Disposable mist filtration system
- Solution level indicator
- Detachable door for easy cleaning of unit
- Easy replenishment of solution tank
- Air pressure gauge
- Oil flow control valve



H6000
(3 high speed positions)



• Saves Time

• Simple to Operate

• Optimizes Performance



H6005

- 2 high speed positions
- 1 low speed E-type motor



H6025

- 1 high speed positions
- 2 low speed E-type motor



H6150-Kavo
kavo maintenance coupler



H6155-NSK
NSK maintenance coupler



H6165-W&H
W&H maintenance coupler



H6145-MW
Quick Connect for Midwest Slow Speed



H6160-BienAir
BienAir maintenance coupler



H6175-E-Type
4 Hole to E-Type Adaptor

Description	Model	Suggested Retail Price	
H6000 Handpiece cleaning and lubrication system	H6000		
H6005 Handpiece cleaning and lubrication system		H6005	
H6025 Handpiece cleaning and lubrication system			H6025

Package includes the following:

3 high speed handpiece positions	✓		
2 high speed / 1 low speed E-type motor		✓	
1 high speed / 2 low speed E-type motor			✓
Mist filters (pack of 12)	✓	✓	✓
Lubrication fluid	✓	✓	✓
Air filter	✓	✓	✓

Options:

H6125	Lubrication fluid
H6130	Mist filter (pack of 12)
H6135	Oil absorbent door strips (pack of 20)
H6150-Kavo	Kavo type HP adapter
H6155-NSK	NSK type HP adapter
H6160-BienAir	Bien Air type HP adapter
H6165-W&H	W&H type HP adapter
H6145-MW	Quick connect for Midwest Slow Speed
H6175-E-Type	4 Hole to E-Type Adaptor

Packing Dimensions: 17"L x 15"W x 18"H / 24 lbs.

Retail

Advance 2505

LED Bleaching System



Features

- Quiet fan operation
- Multi-arch whitening application
- Three high intensity LED's
- Digital display with audio feedback
- High power Blue and UV light emitting diodes
- Compact mobile stand for easy storage
- Adjustable bleaching time with microprocessor-controlled timer
- Smart auto-select power: 110-240 Volts AC, 50/60 Hz
- LED bleaching system includes illuminator, mobile base, adjustable arm, power cord & user manual
- 2 year warranty



Specifications:

Broad-spectrum:	395–490 nm
Light intensity:	1,500 mW/cm ²
Weight:	14 lbs.
Dimensions:	60" (H) X 20" (W)
Voltage output:	110-240 V / 50-60 Hz
Packing Dimensions:	21" x 21" x 6" / 14lbs.

Description

Advance 2505 LED Bleaching Light

Model

ALED 2505

Suggested Retail Price

Package includes the following:

- Advance 2505 LED Bleaching Light
- Mobile stand
- AC power supply
- 2 Year warranty





LED 70N

Cordless Curing Light System

Specifications and Accessories

Switching Power Adapter

Power supply: AC 100-240V / 50-60 Hz
 Dimensions: 10"L x 2"W x 8"H

Hand Piece

Light source: 10W light
 Emitting diode
 Wavelength: 430-490 nm
 Light Intensity: 2,000 mW/cm²
 Battery: Lithium ion



ALED-70

Features

- Low battery signal – visual and audible alarm
- Easy to read – LCD display
- High light intensity – 5 to 10 second cure
- No down time
- Flexibility – corded and cordless light cure
- Quiet fan – extends life of LED
- Sleep mode – conserves power, saves battery life
- Fast mode – 3 output modes 2,000 – 1,500 – 1,000
- Built-in radiometer

Standard Accessories

- LED 70 Handpiece
- Charging base
- 8mm light guide
- Eye protector
- Lithium ion battery
- Power supply
- User's manual

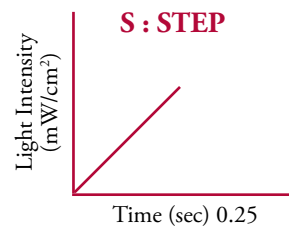
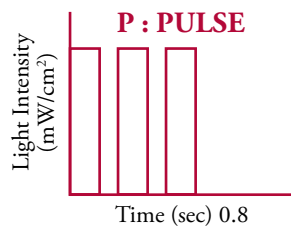
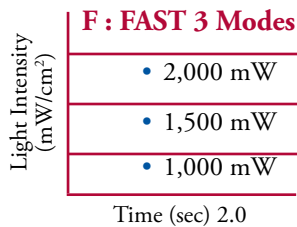

Description

LED 70 cordless curing light

Model

ALED-70

Suggested Retail Price

Package includes the following:

- LED 70 cordless curing light
- Charging base
- Protective eye-shield
- Countertop stand with power indicator
- 8mm Light Guide
- Built-in radiometer
- AC power supply



Options:

- P109-LG Replacement light guide (8mm)
- P208 Replacement protective eye-shield
- ALED 70N-BATT Replacement rechargeable battery for LED 70
- P117 11mm light guide

Retail

Shipping Dimensions: 11"L x 8"W x 4"H / 3 lbs.
 (10/cs.) 18"L x 12"W x 16"H / 25 lbs.



LED 60N

Cordless Curing Light System

Specifications and Accessories

Switching Power Adapter

Power supply: AC 100-240V / 50-60 Hz
 Dimensions: 10"L x 2"W x 8"H

Hand Piece

Light source: 5W light
 Emitting diode
 Wavelength: 430-490 nm
 Light Intensity: 1,400 mW/cm²
 Battery: Lithium ion



ALED-60

Features

- Low battery signal – visual and audible alarm
- Easy to read – LCD display
- High light intensity – 5 to 10 second cure
- No down time
- Flexibility – corded and cordless light cure
- Quiet fan – extends life of LED
- Sleep mode – conserves power, saves battery life
- Built-in radiometer

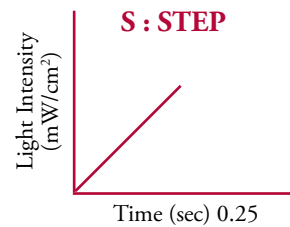
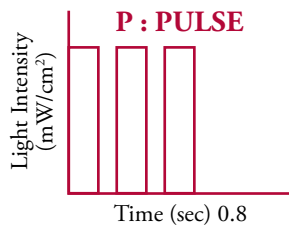
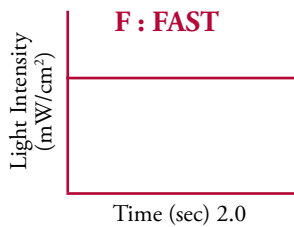

Standard Accessories

- LED 60 Handpiece
- Charging base
- 8mm light guide
- Eye protector
- Lithium ion battery
- Power supply
- User's Manual

Description

LED 60N cordless curing light

Model

ALED-60N

Suggested Retail Price

Package includes the following:

- LED 60N cordless curing light ✓
- Charging base ✓
- Protective eye-shield ✓
- Countertop stand with power indicator ✓
- 8mm light guide ✓
- Built-in power radiometer ✓
- AC power supply ✓

Options:

- P109-LG Replacement light guide (8mm)
- P208 Replacement protective eye-shield
- ALED 60N-BATT Replacement rechargeable battery for LED 60
- P117 11mm light guide

Retail

Shipping Dimensions: 11"L x 8"W x 4"H / 3 lbs.
 (10/cs.) 18"L x 12"W x 17"H / 24 lbs.

LED 55N

Cordless LED Curing Light



Specifications

- Battery: Lithium Ion, DC 3.6-4.2V
- Power adapter: 90-250V AC, 50-60 Hz
- Charging base: 9V DC
- Power consumption: 5 W LED
- Wavelength range: 430-490 nm
- Light Intensity: 1,250 mW / cm²
- Dimensions: 7"L x 1"W x 1"H
- Weight: 160 g
- Warranty: 2 year

Benefits

- Ergonomic, light weight design
- High intensity output up to 1 hour before recharging
- Cordless for ultimate convenience
- Cures most materials in 5-10 seconds
- Curing time: 20 seconds per cycle with beep every 10 seconds
- 2 Batteries included.

Charging Stand Light Indicators

LED color	Light Strength
Green	Normal
Orange	Light strength insufficient

Curing Status Light Indicators

LED color	Status Indication
Green	Normal
Red	Battery Voltage Low
Red Flashing	LED curing light handpiece is over temperature

Curing Mode Light Indicators

LED color	Working Mode
Green	Fast curing: Time setting 20 seconds (every 10 second, it sounds once)
Red	Pulse curing: interrupt radiating (every 10 seconds, it sounds once)
Orange	Step curing: soft start for 10 second from 0 to full power, then full power during the later 10 second



Charging Stand



ALED55N-1-G

ALED55N-1-R

ALED55N-1-B

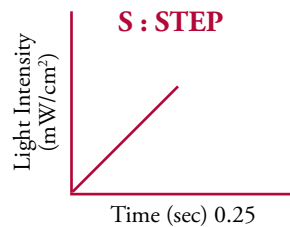
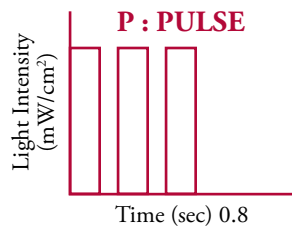
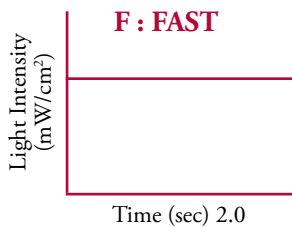

LM-300

Description

- LED 55N Cordless Curing Light Silver
- LED 55N Cordless Curing Light Blue
- LED 55N Cordless Curing Light Red

Model

- ALED55N-1-G Silver
- ALED55N-1-B Blue
- ALED55N-1-R Red

Suggested Retail Price

Package includes the following:

- LED 55N cordless curing light ✓
- Charging stand with power indicator ✓
- Protective eye-shield ✓
- AC power supply ✓

Options:

- P109-LG Replacement light guide for LED 55 (8mm)
- ALED55N-BATT Replacement battery
- P208 Replacement protective eye-shield
- P117 11mm light guide
- LM300 Curing light meter

Retail

Shipping Dimensions: 10"L x 7"W x 4"H / 3 lbs.
(10/cs.) 21"L x 11"W x 14"H / 24 lbs.

LED 55BN

Built-in Curing Light System



Specifications

- Wavelength range: 430-490 nm
- Light Intensity: 1,250 mW / cm²
- Warranty: 2 year
- Power consumption: 5 W LED

Model ALED55-BN



LM-300



Curing Mode Light Indicators

LED color	Working Mode
Green	Fast curing: Time setting 20 seconds (every 10 second, it sounds once)
Red	Pulse curing: interrupt radiating (every 10 seconds, it sounds once)
Orange	Step curing: soft start for 10 second from 0 to full power, then full power during the later 10 second

Curing Status Light Indicators

LED color	Status Indication
Green	Normal
Red Flashing	LED curing light handpiece is over temperature

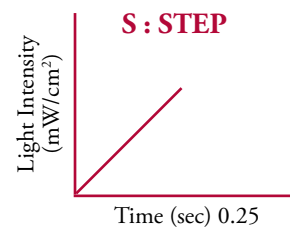
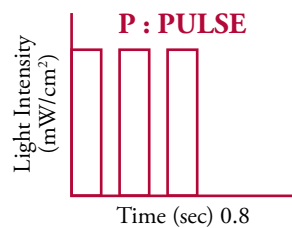
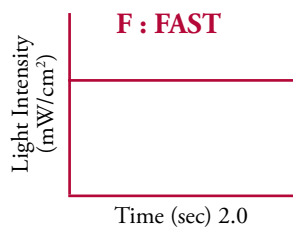

Description

Model

Suggested Retail Price

LED 55BN Built-in Curing Light (LED 5W installed in dental unit)ALED55BN-A (110V - 240V)
 LED 55BN Built-in Curing Light (LED 5W installed in dental unit)ALED55BN-E (24V)

Package includes the following:

Turbo Light Guide ✓
 Protective Eye-Shield ✓

Options:

P109-LG Replacement light guide for LED 55B
 P208 Replacement protective eye-shield
 LED 55BN-PS110 Replacement power supply 110V - 240V
 LED 55BN-PS24 Replacement power supply 24V
 P117 11mm light guide
 LM300 Curing light meter

Retail

Shipping Dimensions: 10"L x 6"W x 2"H / 2 lbs.
 (20/cs.) 21"L x 11"W x 12"H / 27 lbs.



LED 50N

Cordless Curing Light System

Specifications and Accessories

Switching Power Adapter

Power supply: AC 100-240V / 50-60 Hz
 Dimensions: 10"L x 2"W x 8"H

Hand Piece

Light source: 5W light emitting diode
 Wavelength: 430-490 nm
 Light Intensity: 800 - 1000 mW/cm²
 Battery: Lithium ion

Standard Accessories

- LED 50N handpiece
- charging base
- 8mm light guide
- Eye protector
- Lithium ion battery
- Power supply
- User's manual



LM-300



ALED-50N

Features

- Low battery signal – visual and audible alarm
- Easy to read – LCD display
- High light intensity – 5 to 10 second cure
- Flexibility – Cordless light cure
- Sleep mode – conserves power, saves battery life

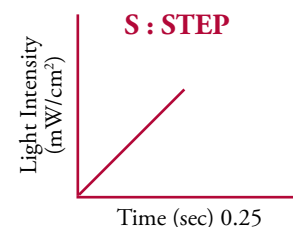
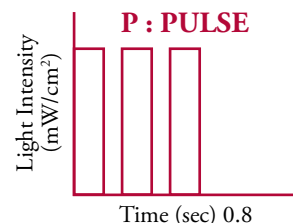
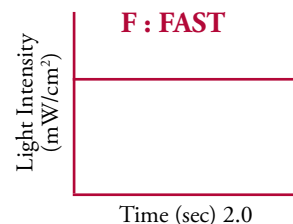

Description

LED 50 Cordless Curing Light

Package includes the following:

- LED 50 cordless curing light
- Charging base
- Protective eye-shield
- Counter top stand with power indicator
- 8mm light guide
- Built-in power transformer
- AC power supply

Model

ALED-50N

Suggested Retail Price

Options:

- P109-LG Replacement light guide (8mm)
- P208 Replacement protective eye-shield
- LED 50-BATT Replacement rechargeable battery for LED 50
- P117 11mm light guide
- LM300 Curing light meter

Retail

Shipping Dimensions: 10"L x 8"W x 5"H / 2 lbs.
 (10/cs.) 24"L x 10"W x 16"H / 20 lbs.

LED 39N

Curing Light System



Specifications

- Class: Class II (ICE601-1)
- Wavelength range: 430-490 nm
- Light Intensity: 1,000 mW / cm²
- Warranty: 2 year

Standard Accessories

- LED 39 handpiece
- Stand
- 8mm light guide
- Eye protector
- Power supply
- User Manual



Built-in
24 V Direct LED39BN

ALED-39N



ALED-39N

Curing Mode Light Indicators

LED color	Working Mode
Green	Fast curing: Time setting 20 seconds (every 10 second, it sounds once)
Red	Pulse curing: interrupt radiating (every 10 seconds, it sounds once)
Orange	Step curing: soft start for 10 second from 0 to full power, then full power during the later 10 second

Curing Status Light Indicators

LED color	Status Indication
Green	Normal
Red Flashing	LED curing light handpiece is over temperature

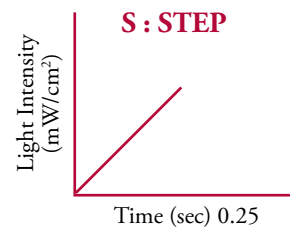
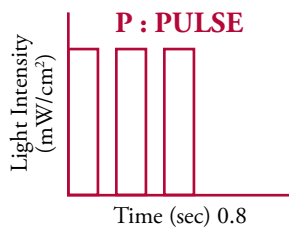
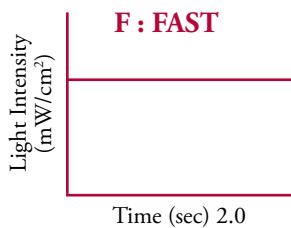

Description

LED 39N Curing Light
LED 39BN Curing Light

Package includes the following:

LED 39 curing light
8mm light guide
Protective eye-shield
Stand
Built-in power transformer

Model

ALED 39N
ALED 39BN (24V)

Suggested Retail Price

Options:

P109-LG Replacement light guide for LED 39N
P208 Replacement protective eye-shield
ALED 39N-PS Replacement power supply

Retail

Shipping Dimensions: 13"L x 7"W x 3"H / 2 lbs.
(20/cs.) 24"L x 14"W x 14"H / 30 lbs.

Power Light 100

Halogen Curing Light







PL-100

Specifications

- Output light intensity: 500-600 mW/cm²
- Output wavelength range: 400-500 nm
- Preset curing times from 10 to 60 seconds or continuous cure
- LCD digital display
- Maintains constant light output and curing strength
- 8 mm light guide, protective eye shield and instruction manual included
- Powerful 75 Watt bulb
- Ultra quiet fan
- 1 year warranty (bulb excluded)

Lighting Guides

	13mm straight for large facial surface
	13mm x 80° for posterior occlusal curing
	8mm x 60° for general curing
	8mm - 3mm x 80° for layer curing of posterior restoration

Description

Power Light 100 Halogen Curing Light

Model

PL-100

Suggested Retail Price

Package includes the following:

Power Light 100 curing light	✓
8mm x 60° curing tip	✓
Protective eye-shield	✓
1 Year warranty	✓

Options:

P101	13mm straight curing tip for large facial surface
P102	13mm x 80 degree curing tip for posterior occlusal curing
P103	8mm x 60 degree curing tip for general curing
P106	3mm x 90 degree curing tip for layer curing of posterior restoration
P201	Replacement bulb, 12V, 75W
P203	Protective eye shield for Power Light 100
L0005	Blue light filter + heat absorber (set).

Retail

Shipping Dimensions: 12"L x 9"W x 6"H / 6 lbs.
(4/cs.) 18"L x 13"W x 12"H / 26 lbs.

LM300

Curing Light Meter



LM-300



Description

LED Light Meter

Model

LM-300

Suggested Retail Price

Package includes the following:

LED Light Meter

✓

Battery

✓

1 Year warranty

✓

Shipping Dimensions: 8"L x 4"W x 2"H / 1 lbs.

Advance 850LED

LED Piezo Scaler w/Bottle System



A850-LED

Standard Scaler Features

- Compact unit housing for easy placement anywhere in the operatory
- Extremely gentle on patient, causes little or no sensitivity
- No heat build up in handpiece tip with extended use
- Autoclavable handpiece
- Extensive power range to allow widest choice of clinical applications includes General, Perio and Endo
- Fine water spray eliminates excessive overspray onto patient
- Bottle water or External water source
- 5 tips included with unit G1, G2, G4, P4, P5
- Endodontic file holder & files included
- Easy and rapid operating for root canal treatment
- Achieve enlargement of canal quickly
- 1 year warranty

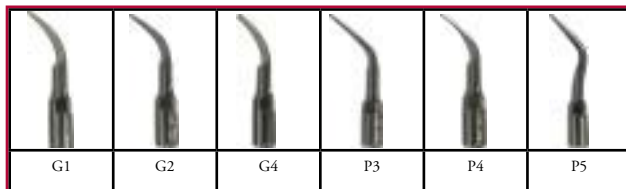

5 Included tips
G1, G2, G4, P4, P5

P3 Optional

Technical Data

- Absorbed Power: Max 15W
- Scaler: Max 10W, 24 -28kHz, automatic tuning
- Water Pressure: 30 - 145 PSI
- Water Consumption: 10 - 50 cc/min
- Approvals: ETL, according to UL - 2601 - 1
- Classification according to Medical Device
- Directive 93/42 EEC: Class 11a



Description

Advance 850-LED Piezo Ultrasonic Scaler & Endodontic Unit

Model

A850-LED

Suggested Retail Price

Package includes the following:

- Advance 850-LED piezo ultrasonic scaler with handpiece
- G1, G2, G4, P4, P5 tips included
- Foot control
- Tip wrench
- Water Bottle
- Endo file holder + files

Indicate EMS or Satellec style tips at time of order

- ✓
- ✓
- ✓
- ✓
- ✓
- ✓

Options

- A760 Endo files and holder (21mm #25)
- A761 Piezo scaler tip #G1
- A762 Piezo scaler tip #G2
- A763 Piezo scaler tip #P3 Slim
- A767 Piezo scaler tip #G4
- A764 Piezo scaler tip #P4
- A766 Piezo scaler tip #P5

Retail

Replacement Parts

Retail

- A746 Piezo scaler handpiece w/ LED
- A776 Tip wrench
- A749 Piezo scaler O-rings (5 pack)
- A778 Replacement water line 7.5' w/ Q.C.
- A775 Replacement scaler foot control
- A850-RP-BTL Replacement water bottle
- A781 Replacement LED HP tubing
- A746-RP101 Replacement LED light

Shipping Dimensions: 18"L x 14"W x 5"H / 6 lbs.
(4/cs.) 18"L x 15"W x 21"H / 26 lbs.

Advance 750LED

LED Piezo Scaler

Standard Scaler Features

- Compact unit housing for easy placement anywhere in the operatory
- intense LED Light Source
- Extremely gentle on patient, causes little or no sensitivity
- No heat build up in handpiece tip with extended use
- Autoclavable handpiece
- Extensive power range to allow widest choice of clinical applications
- Fine water spray eliminates excessive overspray onto patient
- Thin subgingival tips available
- 5 tips included with unit G1, G2, G4, P4, P5

Optional Endodontics Unit Features

- Endodontic file holder
- Easy and rapid operating for root canal treatment
- Achieve enlargement of canal quickly

Specifications

- Input rating: 115/230V, 50/60 Hz
- Dimensions: 160mm(W) x 155mm(D) x 70mm(H)
- Weight: 2.1 kg
- Frequency: 32 KHz
- Water pressure: 1-4 kg/cm²
- Fuses: 230V, 2 per unit ; F0.5A 250V-CQ-S500
- Fuses: 110V, 1 per unit ; F1A 5A 250V-CQ-S500
- 5 tips included with unit G1, G2, G4, P4, P5
- 1 year warranty (tips excluded)



A750LED



5 Included tips
G1, G2, G4, P4, P5

P3 Optional

Description

Advance 750N Piezo Ultrasonic Scaler & Endodontic Unit
Advance 750N Piezo Ultrasonic Scaler & Endodontic Unit W/LED

Model

A750N

Suggested Retail Price

A750LED

Package includes the following:

Advance 850-LED piezo ultrasonic scaler with handpiece
G1, G2, G4, P4, P5 tips included
Foot control
Tip wrench
Water bottle
Endo file holder + files

Indicate EMS or Sateltec style tips at time of order

✓
✓
✓
✓
✓
✓

Options

A760 Endo files and holder (21mm #25)
A761 Piezo scaler tip #G1
A762 Piezo scaler tip #G2
A763 Piezo scaler tip #P3 Slim
A767 Piezo scaler tip #G4
A764 Piezo scaler tip #P4
A766 Piezo scaler tip #P5

Retail

Replacement Parts

Retail

A746 Piezo scaler handpiece w/ LED
A776 Tip wrench
A749 Piezo scaler O-rings (5 pack)
A778 Replacement water line 7.5' w/ Q.C.
A775 Replacement scaler foot control
A745 Replacement Scaler HP Non LED
A781 Replacement HP tubing W LED source
A780 Replacement HP tubing Non LED
A746-RP101 Replacement LED light

Shipping Dimensions: 13"L x 10"W x 5"H / 5 lbs.
(8/cs.) 21"L x 14"W x 18"H / 42 lbs.

Advance 800N

Piezo Ultrasonic Built-In Scaler

A800N

A800LED



Features

- Extremely gentle on patient, causes little or no sensitivity
- No heat build up in handpiece tip with extended use
- Autoclavable handpiece
- Extensive power range to allow widest choice of clinical application
- Fine water spray eliminates excessive overspray onto patient
- Thin subgingival tips available
- 5 tips included with unit G1, G2, G4, P4, P5
- 1 year warranty (tips excluded)

Additional Benefits

- The Advance 800N eliminates the need for external water line and power cord connections
- The Advance 800N operates from unit foot control - no additional foot control needed
- The Advance 800N allows for a clean appearing operatory eliminating all visible tubes and power lines.

Specifications

- Transformer: 24V, 1 amp
- Activated by unit foot control – no additional foot control needed
- Small electronic box, 2-3/8"L x 1.5"W x 1.25"H
- Easy tip system allows tips to be changed easily
- Absorbed power: max 15 watt
- Scaler: max 10 watt, 24-28 kHz, automatic tuning
- Water pressure: 30-145 PSI
- Water consumption: 10-50 cc/min
- No external water line / power cord
- 1 year warranty (tips excluded)
- Indicate EMS or Satellec Tips on all orders

5 Included tips
G1, G2, G4, P4, P5

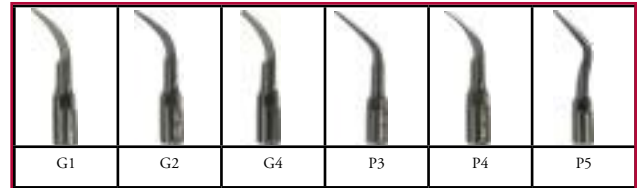

P3 Optional

Description

Advance 800N Piezo Ultrasonic Built In Scaler
Advance 800N Piezo Ultrasonic Built In Scaler W/LED

Package includes the following:

Advance 800N piezo ultrasonic scaler with handpiece
#G1, #G2, #G4, #P4, #P5 tip
Tip wrench
Transformer
Control box
Advance 800 LED handpiece

Model

A800N

A800LED

Suggested Retail Price

Indicate EMS or Satellec style tips at time of order

✓	
✓	✓
✓	✓
✓	✓
✓	✓

Options

A760 Endo files and holder (21mm #25)
A761 Piezo scaler tip #G1
A762 Piezo scaler tip #G2
A763 Piezo scaler tip #P3 Slim
A767 Piezo scaler tip #G4
A764 Piezo scaler tip #P4
A766 Piezo scaler tip #P5

Retail

Replacement Parts

Retail

A746 Piezo scaler handpiece w/ LED
A776 Tip wrench
A749 Piezo scaler O-rings (5 pack)

A745 Replacement Scaler HP non LED
A782 Replacement HP tubing W LED source
A780 Replacement HP tubing non LED
A746-RP101 Replacement LED light
A800N-PCB Main PCB
A800N-WH-HARNESS

Shipping Dimensions: 9"L x 7"W x 4"H / 4 lbs.
(10/cs.) 14"L x 10"W x 18"H / 40 lbs.

PowerMAX25

Ultrasonic Scaling System



Features

- Available in 25Khz
- Precision automatic tuning circuitry
- Linear power control for exact power setting
- Accepts Cavitron®, P, SLI, TFI, and FSI scaler inserts
- Compact and lightweight
- Auto-ranging 110-240 VAC input
- Includes one ultrasonic scaler insert and foot control
- 1 year warranty

Specifications

Weight: 6 lbs

Dimensions: 8"(W) x 8"(D) x 3"(H)

Output power to tip: Operatory adjust approximately 10-40 watts

Handpiece cable: 6'

Power supply to unit: 110-240 VAC Input, 50/60 Hz

Water flow and supply pressure: 18 cc to 30 cc per minute flow from insert tip

Supply pressure to scaler is 25-35 PSI city water or bottle system

Description

Model

Suggested Retail Price

PowerMAX25 Ultrasonic Scaler **with insert**

PM25

Package includes the following:

PowerMAX ultrasonic scaler

✓

25K universal scaler insert

✓

Foot control

✓

1 year warranty

✓

Options:

Retail

S1025	25K universal insert-external water flow	
S1030	30K universal insert- external water flow	
S2025	25K universal slim insert- external water flow	
S2030	30K universal slim insert- external water flow	
S3025	25K universal insert- plastic handle- internal water flow	
S3030	30K universal insert- plastic handle- internal water flow	
S4025	25K universal slim insert- plastic handle- internal water flow	
S4030	30K universal slim insert- plastic handle- internal water flow	
S8001	25K Replacement handpiece w/ Tubing	
PM775	Power Max replacement foot control	
A778	Replacement water line 6' long with male quick disconnect (with shut off)	

Shipping Dimensions: 12"L x 12"W x 4"H / 8 lbs.
(5/cs.) 18"L x 13"W x 14"H / 38 lbs.

Ultrasonic Scaler Inserts



#S1025
25K Universal Scaler Insert
(metal handle)

#S1030
30K Universal Scaler Insert
(metal handle)

Features

- External water
- Interchangeable for use with other brands of scalers
- 90 day warranty against defects arising from faulty materials or workmanship



#S2025
25K Universal Slim Scaler Insert
(metal handle)

#S2030
30K Universal Slim Scaler Insert
(metal handle)

Features

- Slim tip design
- External water
- Interchangeable for use with other brands of scalers
- 90 day warranty against defects arising from faulty materials or workmanship



#S3025
25K Universal Scaler Insert
(black plastic handle)

#S3030
30K Universal Scaler Insert
(black plastic handle)



Features

- Internal water delivery system delivers water directly to the insert tip and focuses it where it is needed most
- Large, round, non-slip plastic grip for greater tactile sensitivity, rotational control and reduced hand fatigue
- Better water management and less water usage means greater patient comfort
- Interchangeable for use with other brands of scalers
- 90 day warranty against defects arising from faulty materials or workmanship
- Ergonomic grip design



#S4025
25K Universal Slim Scaler Insert
(blue plastic handle)

#S4030
30K Universal Slim Scaler Insert
(blue plastic handle)



Features

- Internal water delivery system delivers water directly to the insert tip and focuses it where it is needed most
- Large, round, non-slip plastic grip for greater tactile sensitivity, rotational control and reduced hand fatigue
- Better water management and less water usage means greater patient comfort
- Interchangeable for use with other brands of scalers
- 90 day warranty against defects arising from faulty materials or workmanship
- Ergonomic grip design

Model	Description	Retail
S1025	25K universal insert-external water flow	
S1030	30K universal insert- external water flow	
S2025	25K universal slim insert- external water flow	
S2030	30K universal slim insert- external water flow	
S3025	25K universal insert- black plastic handle- internal water flow	
S3030	30K universal insert- black plastic handle- internal water flow	
S4025	25K universal slim insert- blue plastic handle- internal water flow	
S4030	30K universal slim insert- blue plastic handle- internal water flow	
S8003	Ultrasonic scaler insert O-rings (5 pack)	

Shipping Dimensions: 9"L x 2"W x 1"H / 1 lbs.

AS 5000

Sonic Air Scaler



Features

- Includes 3 tips AS1, AS2, AS3.
- Tip wrench included.
- Light weight
- Portable
- Saves time
- Autoclavable
- Available in 2 or 4 hole.

AS5000-M4

Description	Model	Suggested Retail Price
Air Sonic Scaler -4 Hole Kit	AS5000-M4	
Air Sonic Scaler -2 Hole Kit		AS5000-B2

Package includes the following:

AS5000 Air sonic scaler handpiece	✓	✓
AS1 Universal Tip	✓	✓
AS2 Sickle Tip	✓	✓
AS3 Perio Tip	✓	✓
A776 Tip Wrench	✓	✓
6 Month warranty		

Options:

- AS1 Universal Tip
- AS2 Sickle Tip
- AS3 Perio Tip
- A776 Scaler Tip Wrench Only

Retail

Shipping Dimensions: 9"L x 4"W x 2"H / 1 lbs.

Air Polishing System

Polishing System

EZ Nozzle

- Carefully designed length, angle and curve of nozzle for applications to both anterior and posterior teeth. Allows for accurate direction of the power jet
- Includes two prophy nozzles
- Handpiece nozzle is fully autoclavable up to 134 °C / 273 °F

Ergo Comfort Design

- Fits comfortably in large and small hands. Notched grip allows firm and accurate tip control

Lightweight & Flexible

No Installation Cost

- Simply connects to handpiece tubing
- No extra foot control needed
- No external air or water connections needed

Cleaning Power

- Jet Polishing powder (130g) has a refreshing mint scent

Powder Holder Covers

- Three translucent color coded holder covers are included (blue, green, purple)

Quick Connection

- Simply pull back the quick release ring to release the nozzle from the handpiece



P560

Description	Model	Suggested Retail Price
Air Polishing System	P555-4H	
Air Polishing System		P557-4H
Package includes the following:		
1 – 130g of prophy powder	✓	✓
3 – color coded (red, blue, green) powder holder covers	✓	✓
2 – nozzles (360 degree swivel)	✓	✓
1 – cleaning tool	✓	✓
1 – O-ring set	✓	✓
1 year warranty	✓	✓
Options:		Retail
P560	130g of prophy powder	
P660	Nozzle for P555	
P665	Nozzle for P557	

Shipping Dimensions: 9"L x 8"W x 3"H / 2 lbs.
(10/cs.) 13"L x 13"W x 10"H / 12 lbs.

Ultrasonic Cleaner

Dentsonic UC 400 / 1000



Model UC-400

Features

- Powerful 40 KHz of cavitation for thorough, quieter cleaning
- Stainless steel cover and tank with welded drain
- Durable vinyl clad steel housing is scratch resistant and easy to clean
- Digital timer for quick and easy process
- Sweep technology ensures exceptional cleaning efficiency
- 1 year warranty
- 2 tank sizes available 3.8 qt / 10.6qt
- Includes basket and lid



Stainless Steel Cover



Stainless Steel Basket



Drain kit only available on UC1000

MODEL	UC-400	UC-1000
Input 115V	✓	✓
Input 230V	✓	✓
Frequency	50/60 Hz	50/60 Hz
Overall Dimensions L x W x H	10.6" x 6.3" x 9.5" 27cm x 16cm x 24cm	14.2" x 10.6" x 12.2" 36cm x 27cm x 31cm
Tank Internal Dimensions L x W x H	9.5" x 5.5" x 4" 24cm x 14cm x 10cm	11.8" x 9.5" x 5.9" 30cm x 24cm x 15cm
Ship Weight	10 lbs. 4.5 Kg	19 lbs. 8.6 Kg
Tank Capacity	3.8 Qts. / .95 Gallon 3.59 Liter	10.6 Qts. / 2.65 Gallon 10 Liter
Timer	LCD Display 1-99 minutes	LCD Display 1-99 minutes
302 StainlessSteel	✓	✓

UC-400 14 "L x 13"W x 11"H / 11 lbs.

UC-1000 17 "L x 15"W x 16"H / 21 lbs.

Description

Model

Retail Price

UC-400 Ultrasonic Cleaner (3.8 qt.)
UC-1000 Ultrasonic Cleaner (10.6 qt)

UC-400

UC-1000

Package includes the following:

Ultrasonic cleaner	✓	✓
Stainless steel basket	✓	✓
Stainless steel lid	✓	✓
Drain kit		✓
Timer	✓	✓

Options

Retail Price

UC400-BASKET	Replacement Basket (3.8 qt.)
UC1000-BASKET	Replacement Basket (10.6 qt)

Dentsonic

Ultrasonic Cleaner



UC-250



Features

- Powerful 35 KHz of cavitation for thorough, quieter cleaning
- Stainless steel tank
- Durable plastic housing is scratch resistant and easy to clean
- Digital timer for quick and easy process
- Sweep technology ensures exceptional cleaning efficiency
- 2 tank sizes available 2.5qt., 3.0qt.
- Includes basket and lid
- 1 year warranty



UC-300

Shipping Dimensions

UC-250	14"L x 11"W x 10"H / 8 lbs. (4/cs) 23L x 15W x 20H / 35lbs.
UC-300	20"L x 14"W x 12"H / 16 lbs. (2/cs) 20"L x 14"W x 24"H / 34Lbs



UC-600-GBS
Glass Beaker Set
500 ML x 2 and holder
Fits: UC300, 600, 750



UC-300-S

Model	UC-250	UC-300
Input 115Vac	✓	✓
Input 220Vac	✓	✓
Frequency	50/60 Hz	50/60 Hz
Overall dimensions	12.6" x 9.6" x 8.0"	17.5" x 10.8" x 8.1"
Tank Internal Dimensions	9.8" x 6.0" x 3.0"	9.8" x 7.0" x 3.0"
Shipping Weight	8 lbs	13 lbs
Tank Capacity	2.5 qt, 0.65 Gal, 2.46 L	3.0 qt, 0.8 Gal, 3.028 L
Digital Timer	LCD Display 1-30 min	LCD Display 1-30 min
302 Stainless Steel Tank	✓	✓

Description

UC-250 Ultrasonic Cleaner 2.5 Qt UC-250
UC-300 Ultrasonic Cleaner 3.0 Qt (W/ Stainless Steel Basket) UC-300-S

Options

UC-600-GBS Glass Beaker Set (500ML X 2 and holder) Fits UC 300, UC600, UC 750

Model

Suggested Retail Price

UC-300-S

Model

Package includes the following:

Ultrasonic cleaner	✓	✓
Basket	✓	✓
Lid	✓	✓
Drain kit	✓	✓
Digital timer	✓	✓
Heater	✓	✓

Dentsonic

Ultrasonic Cleaner

Features

- Powerful 35 KHz of cavitation for thorough, quieter cleaning
- Stainless steel tank
- Durable plastic housing is scratch resistant and easy to clean
- Digital timer for quick and easy process
- Sweep technology ensures exceptional cleaning efficiency
- 2 tank sizes available
 - 1.6 Gallon
 - 2.0 Gallon
- Includes basket and lid
- 1 year warranty



UC-600



Shipping Dimensions

UC-600 23 "L x 16"W x 14 "H / 23 lbs.

UC-750 24 "L x 16"W x 14"H / 27lbs.



UC-600-S



UC-750

Model	UC-600	UC-750
Input 115Vac	✓	✓
Input 220Vac	✓	✓
Frequency	50/60 Hz	50/60 Hz
Overall dimensions	21.0" x 12.0" x 9.6"	21.3" x 13.3" x 10.9"
Tank Internal Dimensions	13" x 8.0" x 4.0"	13" x 9.4" x 4.1"
Shipping Weight	20 lbs	25 lbs
Tank Capacity	6.4 qt, 1.6 Gal, 6.056 L	8 qt, 2 Gal, 7.5 L
Digital Timer	LCD Display 1-30 min	LCD Display 1-30 min
302 Stainless Steel Tank	✓	✓

Description

UC-600 Ultrasonic Cleaner 1.6 Gallon Plastic Basket

UC-600

UC-600 Ultrasonic Cleaner 1.6 Gallon Stainless Steel Basket

UC-600-S

UC-750 Ultrasonic Cleaner 2.0 Gallon Stainless Steel Basket

UC-750

Package includes the following:

Ultrasonic cleaner

✓

✓

Basket

✓

✓

lid

✓

✓

Drain kit

✓

✓

Digital timer

✓

✓

Heater

✓

✓

Options

UC600-BSKT-P

Replacement Plastic Basket

UC600-BSKT-SS

Replacement Stainless Steel Basket (70cm)

UC750-BSKT-SS

Replacement Stainless Steel Basket (70cm)

Model

Suggested Retail Price

Suggested Retail Price

TPC Dentsonic Ultrasonic Cleaner

Cassette Cross reference

851 South Lawson Street City of Industry CA 91748 • tpcdental.com • 800-560-8222

	UC-250	UC-300	UC-400	UC-600	UC-750	UC-1000
Internal Basket Size (L x W x H)	8.25" x 8" x 7"	8.25" x 8.25" x 7"	7.125" x 4.125" x 2.75"	10.25" x 7.125" x 3.25"	10.25" x 8.75" x 4.125"	12.5" x 8.25" x 4.125"
	Stainless Steel Baskets			10.25" x 8.125" x 3.25"	11.125" x 8" x 2.25"	
Hin-Friesty						
Large Cassette 16-Instruments 8" x 11" x 1.25"		✓		✓	✓	✓
Large Cassette 20-Instruments 4.5" x 8" x 1"		✓		✓	✓	✓
Small Cassette 8-Instruments 5.5" x 8" x 1.25"	✓	✓	✓	✓	✓	✓
Small Cassette 10-Instruments 5.5" x 8" x 1.25"	✓	✓	✓	✓	✓	✓
Room Cassette 5-Instrument 3" x 8" x 1.25"	✓	✓	✓	✓	✓	✓
Space Saver 7-Instrument 4.5" x 8" x 1"	✓	✓	✓	✓	✓	✓
Double Deterger Cassette 8-Inst. 3" x 8" x 1.5"	✓	✓	✓	✓	✓	✓
Double Deterger Cassette 14-Inst. 4.5" x 8" x 1.5"	✓	✓	✓	✓	✓	✓
Double Deterger Cassette 20-Inst. 6" x 9.7" x 1.5"		✓	✓	✓	✓	✓
Signa Stat Cassette 12-Inst. 6.5" x 10.5" x 1.25"				✓	✓	✓
Oral Surgery Cassette 12-Inst. 8" x 14.5" x 1.25"						
Radiography Cassette 4.5" x 8" x 1.5"		✓	✓	✓	✓	✓
Handpiece Cassette 3" x 8" x 1.25"	✓	✓	✓	✓	✓	✓
Ultrasonic Insert Cassette 1.5" x 8" x 1.25"	✓	✓	✓	✓	✓	✓
Zirc						
B-Z Jett Cassette 10-Place 7.875" x 7" x 1.125"				✓	✓	✓
B-Z Jett Cassette 8-Place 7.875" x 4.4375" x 1.125"	✓	✓	✓	✓	✓	✓
B-Z Jett Cassette 5-Place 8" x 3.125" x 1.1875"	✓	✓	✓	✓	✓	✓
Compact Cassette 7.125" x 3.875" x 1.625"	✓	✓	✓	✓	✓	✓
Mini Mat 3.875" x 3.5" x .5"	✓	✓	✓	✓	✓	✓
Instrument Mat 6.75" x 2" x 1.375"	✓	✓	✓	✓	✓	✓
Standard Steri-Container 8.125" x 1.875" x 1.875"	✓	✓	✓	✓	✓	✓
Compact Steri-Container 7.125" x 1.5" x 1.5"	✓	✓	✓	✓	✓	✓

Warning: There should absolutely be NO metal-metal contact inside of the tank during ultrasonic cycle

This includes No direct: Loose Instrument-to-Instrument, Cassette-to-Tank, Cassette-to-Cassette, Cassette-to-Basket, metal contact. Make sure Cassettes have standard silicone insulations and feet; if no basket is used.

Tank Dimensions are measured without baskets; basket sizes vary depending on unit.

Please contact your cassette manufacturer or TPC if you have any questions.

D650N

Digital Amalgamator



D-650N

Features

- ISO 9002 / ISO 13488 quality management certified
- Input voltage: 110V or 230V
- Touch pad selector
- Pre-programmed time settings
- Quiet, high-speed mix capsules
- Built-in automatic timer
- Accepts all capsules
- Customized trituration times
- Vibration frequency \geq 4,400 RPMs
- 1 year warranty

Description

D650N Digital Amalgamator

Model

D-650N

Suggested Retail Price

Package includes the following:

D650N digital amalgamator

✓

AC power cord

✓

Shipping Dimensions: 13"L x 10"W x 10"H / 10 lbs.
(2/cs.) 20"L x 14"W x 10"H / 20 lbs.

N7

Micromotor and Handpiece



Features

- Powerful torque and variable speed motor
- No heat after long hours of operation
- Easy change of driving direction for efficiency
- Variable speed foot control
- Compact and ergonomic design
- Automatic stop with alarm beep and overload reset
- Includes control unit, motor handpiece and foot pedal
- 0–35,000 RPMs
- 110/220V ; 50/60Hz, 0.7A
- 1 year warranty

Description	Model	Suggested Retail Price
-------------	-------	------------------------

TPC Marathon N7 Micromotor and Handpiece	MM7	
TPC Marathon N2 Micromotor and Handpiece	MM2	

Package includes the following:

N7 micromotor and handpiece	✓
AC power cord	✓
Foot pedal	✓

Options:

MM7-HP	Handpiece only with cable
MM7-MOTOR	Motor control box
MM7-VFC	Replacement foot control
MM7-BR	Replacement carbon brushes

Retail

Shipping Dimensions: 11"L x 11"W x 5"H / 7 lbs.
(8/cs.) 24"L x 12"W x 21"H / 58 lbs.

Digital Thermometer

Non-Contact Digital-Infrared



Features

- Non-contact design
- Hygienic & professional
- Comfortable to hold
- Fever warning
- Multiple measurement modes
- 1 year warranty

Description

Thermometer, Non-Contact Digital Infrared

Model

PPE-DT

Suggested Retail Price

Shipping Dimensions:

Deluxe Autoclavable Valve

Autoclavable High Vacuum Valve – Short



Part No.	Description	Retail
#P2330	Deluxe Autoclavable high volume ejector–short	
#P2166	Replacement Deluxe HVE lever & spool	
#P2166-ORING	Spool o-ring (set of 2)	
#2000-HVETUBING	HVE Tubing per foot.	
#HVEBC	HVE valve base connector	

- Autoclavable valve
- Finger tip lever control for on/off flow
- Swivel quick disconnect for 360° rotation
- Adapts to 1/2" ID vacuum tubing
- Disconnect at swivel for simple autoclaving
- Anodized aluminum one piece valve body construction with anodized aluminum swivel

Autoclavable High Vacuum Valve – Long



Part No.	Description	Retail
#P2335	Deluxe Autoclavable high volume ejector–long	
#P2166	Replacement deluxe HVE lever & spool	
#P2166-O-RING	Spool o-ring (set of 2)	
#2000-HVETUBING	HVE Tubing per foot.	
#HVEBC	HVE valve base connector	

- Autoclavable valve
- Ultra smooth lever control for on/off flow
- Swivel quick disconnect for 360° rotation
- Adapts to 1/2" ID vacuum tubing
- Disconnect at swivel for simple autoclaving
- Anodized aluminum one piece valve body construction with anodized aluminum swivel

Autoclavable Saliva Ejector Valve



Part No.	Description	Retail
#P2340	Deluxe Autoclavable saliva ejector valve	
#P2169	Replacement deluxe saliva ejector lever & spool	
#P2185	Replacement deluxe saliva ejector rubber tip <u>only</u> (5 pcs/Bag)	
#2000-SETUBING	Saliva ejector tubing (per foot)	

- Autoclavable valve
- Ultra smooth lever control for on/off flow
- Swivel quick disconnect for 360 degree rotation
- Disconnect at swivel for simple autoclaving
- Anodized aluminum one piece valve body construction with anodized aluminum swivel



Curing Bulb

- 12 Volt 75 Watt
- Power Light 100
- Replacement for PL100

#P201



Operator Light Reflector

- Quality coated glass
- No core charge
- Original factory OEM specifications
- Replacement reflector for Belmont®, LSM® and Celux lights

#P705



Scaler Tubing 25K without Connector

- 25KHz 3-wire handpiece assembly
- 7' length
- Only Compatible with TPC brand scalers

#S8001



Flow Control Valve

- Chrome plated brass
- Side Ported

#52007



Mini HP Control Block

- Mini control block for 3 handpieces
- Solid brass construction
- Extra mounting holes allow a variety of placements
- 10-32 threaded barbs
- Longest lasting inter-woven diaphragm
- High flow design

#52003

#52004 Diaphragm



Water Bottle System

- 1000 ml Extra Heavy duty bottles
- Easy to read pressure gauge
- Pre-set integrated regulator
- Ideal for Anti-bacterial solutions
- Post clamp
- Will mount to vertical surface

#W5030

#W5040 - 1000 ml bottle only !



Flow Control Valve

- Chrome plated brass
- Side / Back Ported

#2600-RP-52007



Momentary Valve

- Chrome plated brass

#52008 \$ 11.00



On/Off 2-Way Valve

- Chrome plated brass

#52009 \$ 11.00



On / Off 3 Way Valve

- Chrome plated brass
- #52010 :



Check Valve

- Chrome plated brass
- #52019



Routing Valve

- Chrome plated brass
- #53014 :



Non-Retraction Water Relay Valve

- Chrome plated brass
 - Equivalent to DCI #7068
- #52011



4-hole Adapter, Metal

- Quality plated brass
- #52039



Plated Brass Nut 4-hole Midwest

- Brass extends HP thread life
 - Standard connector
- #52040



HP Tubing Adapter, 2-hole HP to 4-hole Tubing

- Adapts 2 hole HP to 4-hole tubing
- #52041



HP Tubing Adapter, 4-hole HP to 2-hole Tubing

- Adapts 4-hole HP to 2-hole tubing
- #52042



Stainless Steel Tray

- Premium quality stainless steel
 - Size 13F (9-3/4" x 13-1/2")
- #52026
#52027 Skid Pad

Parts



Female Quick Disconnect

- Panel mount with auto shut-off
- 1/4" poly-flow rear connection
- Chrome plated brass
- 1/4" Coupler

#53012



Male Quick Disconnect w/ Shut-off

- With auto shut-off
- 1/4" poly-flow rear connection
- Chrome plated brass
- 1/8" Male QD

#53042



Male Quick Disconnect w/ Shut-off

- With auto shut-off
- 3/8" poly-flow rear connection
- Chrome plated brass
- 3/8" male QD

#53043



1/4" Coupler with shut off

- Barb type
- Chrome plated brass
- Equivalent to DCI #0006

#53047



Foot Control, Wet/Dry

- Precision-touch disc foot control with wet/dry toggle
- Weighted for maximum stability
- Durable chrome steel dome
- Smooth, variable pressure control
- Non-skid foot pads

#53200

#53200-TS Toggle (only)

#53121 Toggle assembly \$



Foot Control, Shrouded

- Large stable base with shroud
- Precision-touch disc foot control
- Weighted for maximum stability
- Durable chrome steel dome
- Smooth, variable pressure control
- Non-skid foot pads

#53117



4 Hole HP Straight Asepsis Assembled

- Assembled with metal adapter / nut
- Silicone Jacket
- 5.5' length

#52036



Syringe Tubing

#52038

- 6' Silicone Jacket tubing



Air Electric Switch

- Normally open air switch
- 15 PSI activated Check this spec

#A800N-SW

Parts



53016-S

53016-L

Disposable Amalgam Traps

- 53016-S-100 1 7/8" Clear
- 53016-L-100 2 1/8" Clear
- Clear trap pkg of 100

#53016-S-100

#53016-L-100



Solids Collector Canister

- Includes: Lid, Base, o-ring
- Bottom ported 2015 unit
- 2 1/8" trap

#53008



Solids Collector Canister

- Includes: Lid, Base, o-ring
- Side ported for 3550 unit
- 2 1/8" trap

#53008-R



Solids Collector Canister

- Includes: Lid, Base, o-ring
- Bottom ported, 2600 unit
- 1 7/8" trap

#53008-2600



Nylon Bushing

#LP-RI-S

- OD 1 7/8"
- ID 1 3/8"



Nylon Bushing

#LP-PC-L

- OD 1 7/8"
- ID 1 11/16"



Nylon Bushing

#L600N-ARM-RP24

- OD 1 7/8"
- ID 40mm
- L600N Arm Only



48" Light Post

#LP48

- 48" light post
- LP-PC-L included
- Optional: LP-RI-S



Swing Light Post Upper part

#LP-26 \$

- Upper post for LP100



BLMT Radius Bracket (Unit)

#2400-BRKT-BEL

- Fits: BLMT 20, 50



BLMT Rear Radius Bracket (Oblong Shape)

#2450-BRKT-BEL-N

- Fits: BLMT 50 Rear Mount

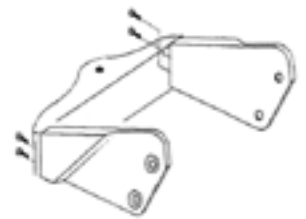

BLMT Rear Radius Bracket (U shape)

#2450-BRKT-BEI



Chair Adaptor

#BELBRKT

- BLMT Chair Bracket
- Fits BLMT 20 / 50 chairs
- Reversible left or right



Chair Adaptor

#TPCBRKT

- TPC chair bracket
- Fits Mirage 1-2, Laguna 2.0
- Reversible left or right



Chair Adaptor

#TPCRDSBKT

- TPC swing bracket
- Fits Mirage 1.0 - 2.0
- Fits LP100, LP105 Post



Chair Adaptor

#L2000-BKT

- Laguna chair bracket
- Fits Laguna 1.0 only

Parts PC2630 / PC 2930



Waste Container

- Fits: PC-2630,2635,3600
OMC2375-CVSL
 - Includes Cap and jar
 - Color: Blue
- #PC-2630N-SWC



Water Bottle

- Water Bottle (Clear)
 - Fits: PC2630, 2635, 3600,
OMC2375, 2930
 - 700 ml
- #PC-2630N-CWB



H.P. holder Automatic

- Panel Mount HP holder
 - Fits: PC2635 only
 - Plastic w/ Metal base
 - Includes: Base, Holder
- #PCP-N-RP1



H.P. holder

- Panel Mount HP holder
 - Fits: PC2630 only
 - Plastic
- #PC-2630N-RP11



On / Off 3 Way Valve

- Chrome plated brass
 - Water bottle on/off
- #52010



Routing Valve

- Chrome plated brass
 - H.P Selector Valve
- #53014



On/Off 2-Way Valve

- Chrome plated brass
 - Suction on / off valve
- #52009



Flow Control Valve

- Chrome plated brass
 - Water Adjustment for PC
2630, 2930
- #52007



1/4" Coupler with shut off

- barb type
 - Chrome plated brass
 - Equivalent to DCI #0006
- #53047



4 Hole H.P. Tubing

- With metal adapter / nut
 - Silicone Jacket
 - 5.5' length
- #52036



Water Relay Block

- 2 position water relay block
- #PC--P2023



Foot Control, Shrouded

- Durable chrome steel dome
 - Smooth, variable pressure control
 - Non-skid foot pads
- #53117



Syringe Tubing

- 6' Silicone Jacket tubing
- #52038



Power Switch

- Main power switch
- #PCN-P5001

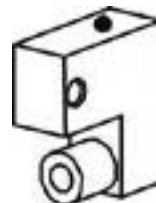

110V Pressure relief valve

- 110V Pressure relief valve
- #PC-P2031



Air Venturi Valve

- S.E. Air Venturi Valve
- #PC-2630-P001

Parts MC3600CV-SL



Waste Container

- Fits: PC-2630,2635,3600 OMC2375-CVSL
 - Includes Cap and jar
 - Color: Blue
- #PC-2630N-SWC
\$17.00



Water Bottle

- Water Bottle (Clear)
 - Fits: PC2630, 2635, 3600, OMC2375, 2930
 - 700 ml
- #PC-2630N-CWB
\$17.00

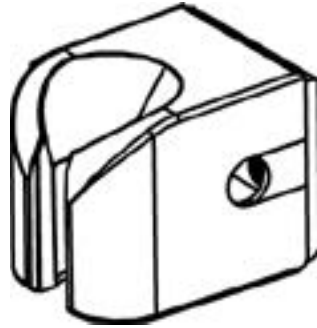

H.P. holder Automatic

- Bar Mount HP holder
 - Fits: MC3600CV/SL
 - Plastic w/ Metal base
 - Includes: Base, Holder
- #MC3600-RP-32
\$60.00
- #MC3600-RP-30 (Valve)
\$60.00



Top Cover

- Plastic top cover
 - Fits: MC3600/3600CV-SL
- #MC3600-RP-1
\$17.00



On / Off 3 Way Valve

- Chrome plated brass
 - Water bottle on/off
- #52010 \$17.00



Routing Valve

- Chrome plated brass
 - H.P. Selector Valve
- #53014 \$17.00



On/Off 2-Way Valve

- Chrome plated brass
 - Suction on / off valve
- #52009 \$17.00



Flow Control Valve

- Chrome plated brass
 - Water Adjustment for PC 2630, 2930
- #52007 \$17.00



1/4" Coupler with shut off

- barb type
 - Chrome plated brass
 - Equivalent to DCI #0006
- #53047 \$17.00



4 Hole H.P. Tubing

- With metal adapter / nut
 - Silicone Jacket
 - 5.5' length
- #52036 \$17.00



Water Relay Block

- 2 position water relay block
- #PC--P2023 \$60.00



110V Main Motor

- 110Vac motor with start cap
 - Quite operation
 - Included mounts, air filter
- #PCP-2530-RP01 \$17.00



Syringe Tubing

- 6' Silicone Jacket tubing
- #52038 \$17.00

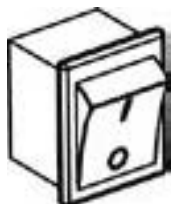

Power Switch

- Main power switch
- #PCN-P5001 \$17.00

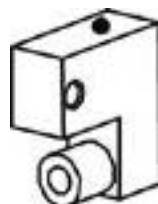

110V Pressure relief valve

- 110V Pressure relief valve
- #PC-P2031 \$60.00

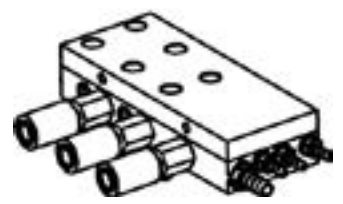

Tri Block

- 3 position Tri Block Complete
- #MC3600-RP-50 \$17.00

Parts OMC2375CV



Waste Container

- Fits: PC-2630,2635,3600
OMC2375-CVSL
 - Includes Cap and jar
 - Color: Blue
- #PC-2630N-SWC



Water Bottle

- Water Bottle (Clear)
 - Fits: PC2630, 2635, 3600,
OMC2375, 2930
 - 700 ml
- #PC-2630N-CWB



H.P. holder Shell

- Bar Mount HP holder
 - Fits: OMC2375CVSL
 - Plastic Shell only
- #OMC-RP-12-C
\$ 16.00

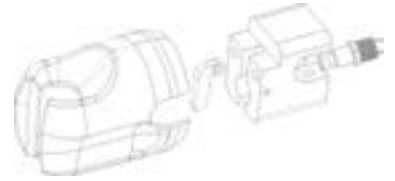

H.P. Holder Complete

- Bar Mount HP holder
 - Fits: OMC2375CVSL
 - Includes: Shell, Block, Valve
- #OMC-RP-12



N.C. Valve

- Normally Closed
 - HP activation valve
- #OMC-RP-13



Routing Valve

- Chrome plated brass
 - H.P Selector Valve
- #53014



On/Off 2-Way Valve

- Chrome plated brass
 - Suction on / off valve
- #52009



Flow Control Valve

- Chrome plated brass
 - Water Adjustment for PC
2630, 2930
- #52007



Pressure Gauge

- OMC Cabinet Pressure Gauge
 - Front Panel Mounted
 - Bracket not included
- #53047



4 Hole H.P. Tubing Silicone Jacket

- With metal adapter / nut
 - Silicone Jacket
 - 5.5' length
- #52036



Water Relay Block

- 2 position water relay block
- #PC--P2023

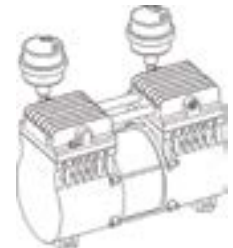

110V Main Suction Motor

- 110Vac motor with start cap
 - Quite operation
 - Included mounts, air filter
- #OMC-2375CV-MTR-1



Syringe Tubing

- 6' Silicone Jacket tubing
- #52038



Power Switch

- Main power switch
- #PCN-P5001

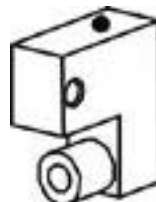

110V Pressure relief valve

- 110V Pressure relief valve
- #PC-P2031

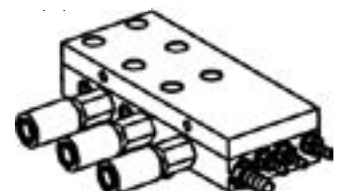

Tri Block

- 3 position Tri Block Complete
- # OMC-RP-17N

Custom Umbilical Lengths / Utility Center

2000 / 2015 Umbilical

- 1 (6 X 4) MM Air "Yellow"
 - 1 (6 X 4) MM Water "Blue"
 - 4 (4 X 2.7mm)
 - Yellow
 - Grey
 - Purple
 - Red
 - 1 (5/8") Drain Line
 - 1 (5/8") Cuspidor Drain 2000 unit
 - 1 (2") Umbilical
 - No Electrical / Low Voltage
- #2015-UMB-FT
#2015-UMB-10 10' length

3500 Umbilical

- 1 (6X4) MM Air "Black"
 - 9 (4 X 2.7mm)
 - Yellow
 - Grey
 - Purple
 - Red
 - Green
 - Blue
 - Maroon
 - Black (spare)
 - Red (spare)
 - No Low Voltage
- #3500-UMB-FT
#3500-UMB-10 10' length

3550 Umbilical

- 1 (6X4)mm Air "Yellow"
 - 1/2" Spiral Loc Tubing
 - Syringe tubing.
- #3550-UMB 6' length
#3550-UMB-10
10' length

MC500 / 501 Umbilical

- 1 6X4MM Air "Black "
 - (1 1/2") Umbilical
 - 8 4 X 2.7mm
 - Yellow
 - Grey
 - Red
 - Green
 - Blue
 - Maroon
 - Black (spare)
 - Red (spare)
 - Purple (spare)
 - 1/2" Spiral Lock Suction
MC501 only Add
\$2.62 per ft
 - Low Voltage
- #MC500-UMB-FT

OMC2375 Umbilical

- 1 6X4MM Air "Yellow"
 - 1 (1 1/2") Umbilical
 - 8 4 X 2.7mm
 - Yellow
 - Grey
 - Clear
 - 5/8" Spiral Lock Suction
 - No Electrical
- #OMC2375-UMB-FT
#OMC2375-UMB-10

MS3000 / MR4000

- 1 6X4mm Air "Black"
 - 8 4 X 2.7mm
 - Yellow
 - Grey
 - Red
 - Green
 - Blue
 - Maroon
 - Black (spare)
 - Red (spare)
 - Purple (Spare)
 - No Low Voltage
- #3000-UMB-FT

Junction Box

- 12.5" X 12.5"
 - Metal frame
 - Plastic top cover
- #53120



Master Shut-Off Valve

- Includes air / water valved
 - 3/8" compression tube
 - Includes pressure regulator
 - Includes pressure gauge
- #53119



Rebulid Kit for 53119

- Diaphragm
 - Spring
 - Plunger
- #53199



40 micron filter

- Use for air and water
 - 40 micron filter element
- #53107



Raw Suction Tubing per Ft.

Part Number	Description	Price per Ft
53096	1/2 Grey Spiral Lock Tubing	\$3.30 Per Ft
53093	5/8" Clear Serial Lock Tubing	\$3.30 Per Ft
53085	5/8" Grey Serial Lock Tubing	\$3.30 Per Ft
53021	2" Umbilical Tubing	\$7.00 Per Ft
2000-HVETubing	1/2" Smooth HVE tubing	\$3.90 Per Ft
2000-SETubing	Saliva Ejector Tubing	\$1.30 per Ft

Corporate Staff Contacts

Customer Care (8:00 a.m. – 5 p.m. PST)
Customer Service Fax Orders

1-626-810-4337
1-626-810-4245



Scott Beckley
Vice President Sales
sbeckley@tpcdental.com



Charlie Nguyen
Handpiece Specialist
charles@tpcdental.com



Mike Carlone
Service / Repair Manager
mcarlone@tpcdental.com



Holly Han
Shipping Manager
holly@tpcdental.com



Ryan Kong
Customer Service
customerservice@tpcdental.com

Jeff Liscano
Technical Support
jliscano@tpcdental.com



851 S. Lawson St. • City of Industry, CA
91748
Tel. (800) 560-8222 • Fax (626) 810-4245

TPC Standard Vinyl Upholstery Color Chart



Desert Rose
LK-34



Grey Teal
LK-49



Taupe
LK-08



Sand
LK-03



Black
LK-72



Atlantis
LK-59

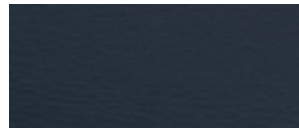

Cobalt
LK-31

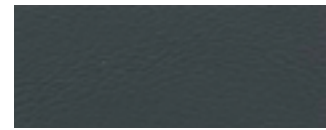

Greystone
LK-11

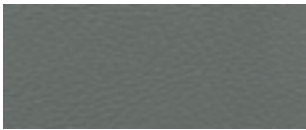

Stormy
LK-04

Morbern Allante FRee Standard Vinyl Color Seletion

Meets CA TB 117-2013 (Section E) Standard

AF colors are subject to upcharge for Laguna Upholstery

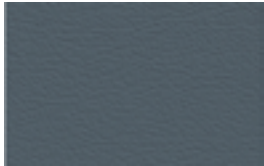

AF-905
Province Blue



AF-916
Red Truffle

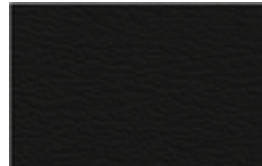

AF-918
Ink Black



AF-920
Galaxy

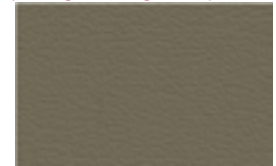

AF-911
Taupe Fawn

Upgraded Naugasoft Upholstery Color Selection

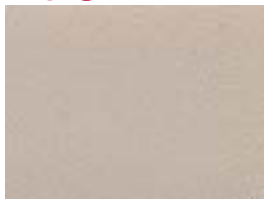

PR 35 Fawn



PR 36 Cabernet

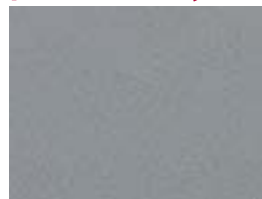

PR 37 Feather



PR 40 Black Satin



PR 46 Blue Fog



PR 49 Deep Sea



PR 50 Lake Louise

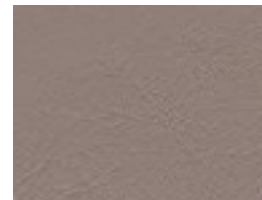

PR 51 Cocoa



PR 52 Saddle



PR 54 Mallard Blue

Description

Models Covered

Retail Price

Dental Chair Naugasoft Upholstery upgrade
 Doctor Stool Naugasoft Upholstery upgrade
 Hygiene Stool Naugasoft Upholstery upgrade
 Assistant Stool Naugasoft Upholstery upgrade
 X-Ray Chair Naugasoft Upholstery upgrade

(PC1000, PC5000)
 (DR1102, DR7000)
 (HY5107)
 (AS1101)
 (XR-6101)

Naugasoft Upholstery Upgrade Charges

www.tpcden tal.com



TPC Advanced Technology, Inc.

851 S. Lawson St. • City of Industry, CA 91748

Tel. (800) 560-8222 • Fax (626) 810-4245